

Canon

DVD Camcorder Instruction Manual

English

DC20/DC10

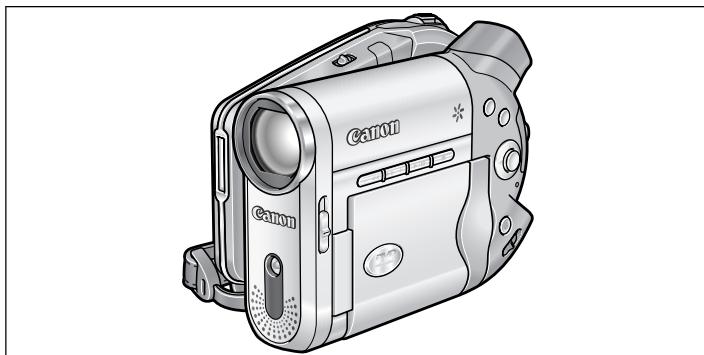

PictBridge

Please read also the following instruction manual.

- **Digital Video Software**



Introduction

Preparations

Basic
Functions

Advanced
Features

Editing
Functions

Disc
Finalization

External
Connections

Printing

Trouble?

Do's & Don'ts

Additional
Information

PAL

Important Usage Instructions

WARNING!



TO REDUCE THE RISK OF ELECTRIC SHOCK, DO NOT REMOVE COVER (OR BACK). NO USER SERVICEABLE PARTS INSIDE. REFER SERVICING TO QUALIFIED SERVICE PERSONNEL.

WARNING!



TO REDUCE THE RISK OF FIRE OR ELECTRIC SHOCK, DO NOT EXPOSE THIS PRODUCT TO RAIN OR MOISTURE.

CAUTION:

TO REDUCE THE RISK OF ELECTRIC SHOCK AND TO REDUCE ANNOYING INTERFERENCE, USE THE RECOMMENDED ACCESSORIES ONLY.

CAUTION:

DISCONNECT THE MAINS PLUG FROM THE SUPPLY SOCKET WHEN NOT IN USE.

CA-570 identification plate is located on the bottom.



Using any device other than the Compact Power Adapter CA-570 may damage the camcorder.

This product has been classified under IEC60825-1:1993 and EN60825-1:1994.

CLASS 1 LASER PRODUCT

An Introduction to DVDs

You have probably heard of DVD discs and they come in various types and in two sizes - the more common 12 cm DVDs and 8 cm Mini DVDs. This camcorder uses 8 cm DVD-R discs (like the supplied one) or DVD-RW discs (commercially available).



So... what disc to choose?



DVD-R

Can be recorded only once.

You cannot edit or delete the recordings.



DVD-RW

You can record it many times.

You can delete scenes or initialize the disc and start recording again.



Now that I have the disc... What disc standard do I choose to initialize it?



VIDEO mode

Once finalized, a disc recorded in VIDEO mode will play in most common DVD players. However, you cannot edit the recordings.

VR* mode

You can easily edit the recordings. However, you will be able to play the disc only with DVD-RW compatible DVD players.

* Video Recording

- **Recommended Discs:** This camcorder's performance was tested using the supplied discs and Hitachi-Maxell HG-series DVD discs. For use of other DVD media, contact directly the manufacturer's customer support center.
- Attempting to record or play in this camcorder DVD discs that were recorded, initialized, edited or finalized with other digital devices can result in lost data.
- You need to initialize newly bought DVD-RW discs with this camcorder before using them for the first time.

The Advantages of DVDs

RECORDING

With a DVD you just press the recording start/stop button and the camcorder will find the empty space on the disc (□ 31). Don't waste time fast forwarding and rewinding a tape to find from where to start a new recording.



Never worry about mistakenly recording over a precious memory!

PLAYING

Just select a scene from the index screen!



Just insert your finalized* disc into a DVD player and immediately find the scene you want to play back from the index. No need to play the whole thing or run the tape forward and back to find that scene you want (□ 37).

SHARING YOUR VIDEOS

Windows users:
With the supplied Roxio MyDVD for Canon software you can easily create copies of your DVDs to share with family and friends and transfer your recordings to a computer for further editing.



For inquiries regarding Roxio MyDVD for Canon, please contact directly the customer support centers of Sonic Solutions (☎ 104).

* Finalization is a process required to make the DVD discs you recorded in VIDEO mode playable on common DVD players (☎ 96).

Table of contents

Introduction

An Introduction to DVDs	3
The Advantages of DVDs	4
About this Manual	9
Checking the Supplied Accessories	11
Components Guide	12
Screen Displays	16

Preparations

Step 1: Preparing the Power Supply	19
Step 2: Preparing the Camcorder	22
Step 3: Using the Wireless Controller	23
Step 4: Adjusting the LCD Screen	24
Step 5: Changing the Display Language	25
Step 6: Setting the Time Zone, Date and Time	26
Step 7: Inserting a Memory Card	28
Step 8: Loading a Disc	29

Basic Functions

Recording

Recording Movies	31
Recording Still Images	33
Zooming	35
Tips for Better Recording	36

Playback

Playing Back Movies	37
Viewing Still Images	39
Adjusting the Volume	41
Magnifying the Image	42
Displaying Additional Recording Data	43

Advanced Features

Recording Programs

Using the Recording Programs	44
Selecting the Recording Program	45
P Using the Program AE Mode	46
Tv Using the Shutter-Priority AE Mode	47
Av Using the Aperture-Priority AE Mode	48

More Recording Options

Manually Adjusting the Exposure	49
Manually Adjusting the Focus and Changing the Focusing Mode	50
Recording in Widescreen (16:9 Aspect Ratio)	52
D\square20 Using the Mini Video Light	53
D\square20 Using the Flash	54
Using the Self-Timer	56

Changing the FUNC. Settings

Changing Settings with the FUNC. Button	57
Available Settings List (FUNC.)	58
Changing the Metering Method	60
Setting the White Balance	61
Applying Image Enhancing Effects	63

Continuous Shooting and Exposure Bracketing	64
Creating Panoramic Images	66
Using the Digital Effects	68
Selecting the Size and Quality of Still Images	74
Capturing a Still Image while Recording Movies	76
Changing the MENU Settings	
Changing Settings with the MENU Button	77
Available Settings List (MENU)	78
Camera Setup (Digital Zoom, Image Stabilizer, etc.)	78
Still Image Operations (Card Initialization, Disc-Card Copy, etc.)	80
Disc Operations (Photomovie, Finalize, etc.)	80
Display Setup (LCD Brightness, Language, etc.)	81
System Setup (Volume, Beep, Media select  , etc.)	81
Date/Time Setup	82
Editing Functions	
Disc Options (DVD-RW in VR mode only)	
Creating a Playlist	83
Dividing a Scene	84
Deleting Scenes	85
Converting Still Images into Photomovie Scenes	87
Protecting the Disc	88
Initializing the Disc	89
Still Image Options	
Copying Still Images Between the Disc and Memory Card	90
Erasing Still Images	92
Protecting Still Images on the Memory Card	94
Initializing the Memory Card	95
Disc Finalization	
Preparing your Disc for Playing on a DVD Player	96
Playing Back your Disc on a DVD Player or a Computer's DVD Drive	98
Recording Additional Movies on a Finalized Disc	99
External Connections	
Connecting to a TV and VCR	
Playing Back on a TV Screen	100
Recording to a VCR	102
Connecting to a Computer	
Transferring Recordings to a Computer	103
Roxio MyDVD for Canon	103
Transferring Still Images to a Computer (Direct Transfer)	108
Transferring Images with Transfer Order Settings	111
Printing	
Printing Still Images	113
Selecting Print Settings	116
Selecting Trimming Settings	119
Printing with Print Order Settings	120
Trouble?	
Troubleshooting	122
List of Messages	127

Do's & Don'ts

Handling Precautions	131
Maintenance/Others	136



Additional Information

System Diagram	137
Optional Accessories	138
Specifications.....	140
Index.....	142

About this Manual



Thank you for purchasing the Canon DC20/DC10. Please read this manual carefully before you use the camcorder and retain it for future reference. Should your camcorder fail to operate correctly, refer to the *Troubleshooting* table (□ 122).

Conventions Used in the Manual

-  : Precautions related to the camcorder operation.
-  : Additional topics that complement the basic operating procedures.
-  : Reference page number.
- Capital letters are used to refer to buttons on the camcorder or the wireless controller.
- [] are used to refer to menu items displayed on the screen.
- "Screen" refers to the LCD and the viewfinder screen.
- Illustrations and screenshots in the manual refer mainly to the DC20.

Step 6: Setting the Time Zone, Date and Time

Setting the Time Zone/Daylight Saving Time

MENU
(□ 79)
 D/TIME SETUP
 T.ZONE/DST

1. Turn on the camcorder (CAMERA or PLAY).
2. Press the MENU button to open the menu.

3. Use the omni selector (▲▼) to select the [D/TIME SETUP] menu and press (○).
4. Use the omni selector (▲▼) to select the [T.ZONE/DST] option and press (○).
The time zone setting appears. The default setting is New York.
5. Use the omni selector (▲▼) to select your time zone and press (○) to save the setting.



Menu item showing at its default position

Button and switches to be operated



About the Omni Selector



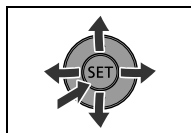











Use the omni selector to select options in a menu and change settings.

Push the omni selector like a joystick up, down, left or right (▲/▼/◀/▶) to select an item. In most places, press the omni selector itself (○) to make a selection or change a setting.



About the Operating Modes

The camcorder's operating mode is determined by the positions of the power switch and the / switch.







Operating Mode	Power Switch	 /  Switch	Icon Display	Operation	
	CAMERA	 (MOVIES)		Recording movies on the disc	31
	PLAY			Playing movies from the disc	37
	CAMERA	 (STILLS)	 or 	Recording still images on the memory card or disc	33
	PLAY		 or 	Viewing still images from the memory card or disc	39

* Depending on whether you choose to save the still images on the disc or memory card.

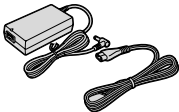
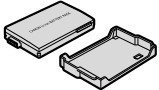
Trademark Acknowledgements

- miniSD™ is a trademark of SD Card Association.
- Windows® is a registered trademark of Microsoft Corporation in the United States and/or other countries.
- Macintosh and Mac OS are trademarks of Apple Computer, Inc., registered in the United States and other countries.
-  is a trademark of DVD Format/Logo Licensing Corporation.
- Manufactured under license from Dolby Laboratories.
“Dolby” and the double-D symbol are trademarks of Dolby Laboratories.
- Other names and products not mentioned above may be trademarks or registered trademarks of their respective companies.

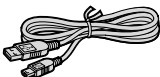
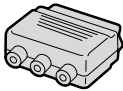
Checking the Supplied Accessories

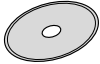
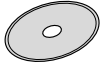
<p>CA-570 Compact Power Adapter (incl. power cord)</p> 	<p>BP-208 Battery Pack</p> 	<p>WL-D86 Wireless Controller</p> 	<p>Lithium Button Battery CR2025 for Wireless Controller</p> 
<p>MTC-100 Multi Cable</p> 	<p>IFC-300PCU USB Cable</p> 	<p>PC-A10 SCART Adapter*</p> 	<p>Blank DVD-R Disc (8 cm Mini DVD)</p> 
<p>DIGITAL VIDEO SOLUTION DISK</p> 	<p>Roxio MyDVD for Canon Software Disc</p> 		

* Not included in China and Oceania.

Components Guide

Left side view

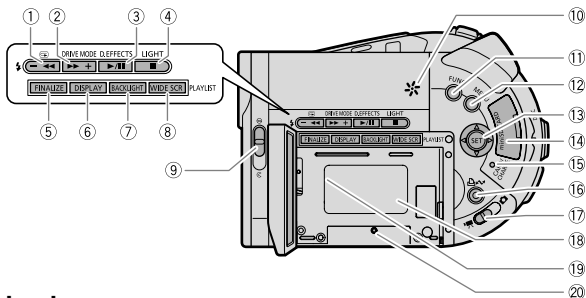

Right side view

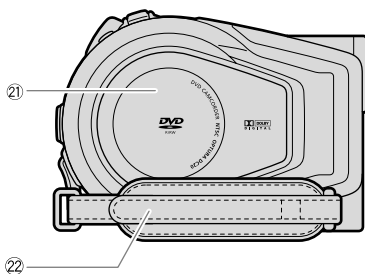

① (record review) button (□ 32) /

◀◀ (rewind) button (□ 38) /

- button (□ 37) /

DC2.0 (flash) button (□ 54)

② DRIVE MODE button (□ 64) /

▶▶ (fast forward) button (□ 38) /

+ button (□ 37)

③ D.EFFECTS button (□ 68) /

▶/|| (play/pause) button (□ 37)

④ **DC2.0** LIGHT button (□ 53) /

■ (stop) button (□ 37)

⑤ FINALIZE button (□ 96)

⑥ DISPLAY button (□ 43)

⑦ BACKLIGHT button (□ 24)

⑧ WIDE SCR button (□ 52) /

PLAYLIST button (□ 83)

⑨ Lens cover switch (□ 31, 33)

(☞ - open, ☹ - closed)

⑩ Speaker (□ 41)

⑪ FUNC. button (□ 57)

⑫ MENU button (□ 77)

⑬ Omni Selector (□ 9) /

EXP button (□ 49) /

FOCUS button (□ 50)

⑭ Memory card slot (□ 28)

⑮ Card access indicator (□ 33) /

Charge indicator (□ 19)

⑯ (print/share) button (□ 105, 108, 114)

⑰ (Movies/Stills) switch (□ 10)

⑱ Battery attachment unit (□ 19)

⑲ Serial number

⑳ Reset button (□ 122)

㉑ Disc compartment cover (□ 29)

㉒ Grip belt (□ 22)

Front view

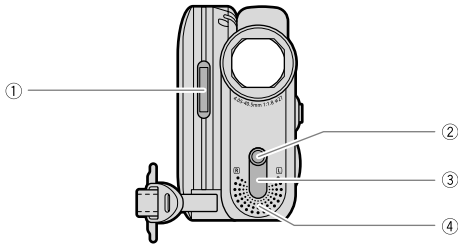

Back view

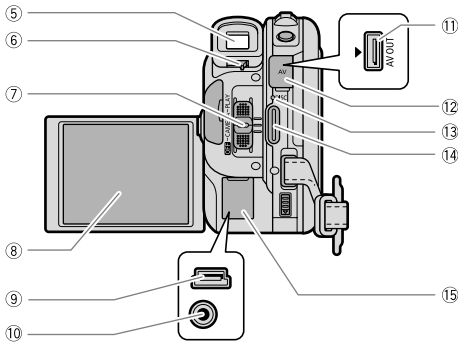

① **DC20** Flash (□ 54)

② **DC20** Mini video light (□ 53)

③ Remote sensor (□ 23)

④ Stereo microphone

⑤ Viewfinder (□ 22)

⑥ Dioptic adjustment lever (□ 22)

⑦ Power switch (□ 10)

⑧ LCD screen (□ 24)

⑨ USB terminal (□ 103, 108, 113)

⑩ DC IN terminal (□ 19)

⑪ AV terminal (□ 100)

⑫ Terminal cover

⑬ Disc access indicator (□ 31)

⑭ Start/stop button (□ 31)

⑮ Terminal cover

Top view

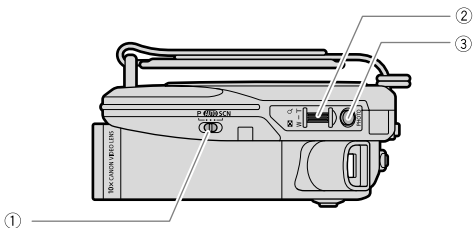

Bottom view

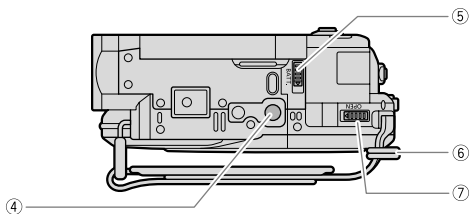

① Mode switch (📖 44)

② Zoom lever (📖 35)

③ PHOTO button (📖 33)

④ Tripod socket (📖 36)

⑤ BATT. button (📖 19)

⑥ Strap mount (📖 139)

⑦ OPEN switch (📖 29)

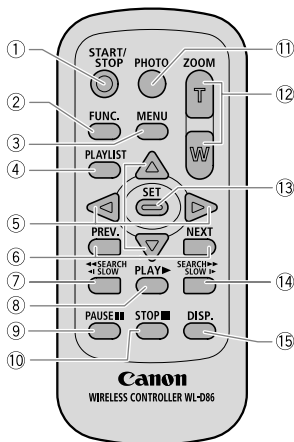

① START/STOP button (□ 31)

② FUNC. button (□ 57)

③ MENU button (□ 77)

④ PLAYLIST button (□ 83)

⑤ Navigation buttons (▲/▼/◀/▶)

⑥ Scene skip buttons (PREV./NEXT) (□ 37)

⑦ Reverse ◀◀ SEARCH button (□ 38) /
Reverse ◀ SLOW button (□ 38)

⑧ PLAY ▶ button (□ 37)

⑨ PAUSE ■■ button (□ 37)

⑩ STOP ■ button (□ 37)

⑪ PHOTO button (□ 33)

⑫ Zoom buttons (□ 35)

⑬ SET button



⑭ Forward SEARCH ▶▶ button (□ 38) /
Forward SLOW ▶▶ button (□ 38)

⑮ DISP. (on-screen display) button (□ 43)

Screen Displays

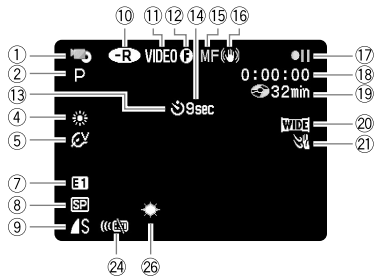

Recording Movies **CAMERA ·**

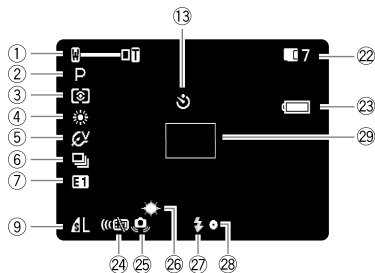

- ① Operating mode (□ 10), Zoom (□ 35), Exposure ( □ 49)
- ② Recording program (□ 44)
- ③ Metering mode (□ 60)
- ④ White balance (□ 61)
- ⑤ Image effect (□ 63)
- ⑥ Drive mode (□ 64)
- ⑦ Digital effects (□ 68)
- ⑧ Recording mode (□ 58)
- ⑨ Still image quality/size (□ 74)
- ⑩ Disc type
 DVD-R,  DVD-RW (□ 3)

Recording Stills **CAMERA ·**



- ⑪ Disc specification
(VIDEO mode, VR mode) (□ 3)
- ⑫ Finalized disc mark (□ 96)
- ⑬ Self-timer (□ 56)
- ⑭ Recording reminder
- ⑮ Manual focus (□ 50)
- ⑯ Image stabilizer (□ 79)
- ⑰ Disc operation
- ⑱ Time code
- ⑲ Remaining recording time on disc (□ 31)
- ⑳ Widescreen mode (□ 52)
- ㉑ Wind screen (□ 79)
- ㉒ Number of still images available
 on the card,  on the disc
- ㉓ Remaining battery charge
- ㉔ Remote sensor mode (□ 23)
- ㉕ Camcorder shake warning (□ 78)
- ㉖ **DC20** Mini video light (□ 53)
- ㉗ **DC20** Flash (□ 54)
- ㉘ AF/AE locked during still image recording (□ 51)
- ㉙ AF frame (□ 51)

14 Recording reminder

The camcorder counts from 1 to 10 seconds when you start recording. This is helpful to avoid scenes that are too short.

17 Disc operation

- Record, ● ■■ Record pause,
- ▶ Playback, ■■ Playback pause,
- ◀◀ Fast reverse playback,
- ▶▶ Fast playback,
- ◀◀ Slow reverse playback,
- ▶ Slow playback

18 Time Code

Indicates the recording time in hours, minutes and seconds.

19 Remaining recording time

Indicates the remaining time on the disc in minutes. When there is no more disc space available, “END” will be displayed and the recording will stop. The camcorder uses a variable bit rate (VBR) when encoding the video data so the actual recording times will vary depending on the content of the scenes and may differ from the remaining time displayed.

22 Number of still images available on the card

- 🔴 flashing in red: No card
 - 🟢 in green: 6 or more images
 - 🟡 in yellow: 1 to 5 images
 - 🔴 in red: No more images can be recorded
- When viewing the still images, the display will always be in green.
 - Depending on the recording conditions, the number of still images available displayed may not decrease even after a recording has been made, or may decrease by 2 still images at once.

Card Access Display

“▶” is displayed next to the number of images available while the camcorder is writing on the memory card or disc.

23 Remaining battery charge



- When “🔴” starts flashing in red replace the battery pack with a fully charged one.
- When you attach an empty battery pack, the power may turn off without displaying “🔴”.
- Depending on the conditions under which the camcorder and the battery pack are used, the actual battery charge may not be indicated accurately.

Playing Movies **PLAY** (Index Screen)



- ① Current scene number/Total number of scenes (37)

- ② Date and time of recording

- ③ Disc operation

- ④ Playback time

- ⑤ Scene number

- ⑥ Data code (43)

Playing Movies **PLAY** (During Playback)



- ③

- ④

- ⑤

- ⑥

Viewing Stills **PLAY**

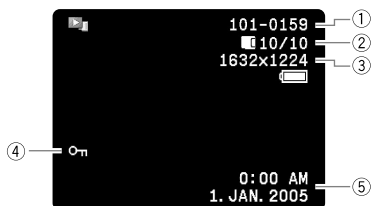

- ① Image number (82)

- ② Current image / Number of images
 recorded on the card,
 recorded on the disc

- ③ Still image size

- ④ Protect mark (94)

- ⑤ Data code (43)

Step 1: Preparing the Power Supply

The camcorder can be powered by a battery pack or be connected to a household power outlet. Charge the battery pack before use.

E

Attaching and Charging the Battery Pack

1. Turn off the camcorder.
2. Attach the battery pack to the camcorder.
 - Open the LCD panel.
 - Slide in the connector end of the battery in the direction of the arrow and press it gently until it clicks.
3. Connect the power cord to the adapter.
4. Plug the power cord into a power outlet.
5. Open the terminal cover and connect the power adapter to the camcorder's DC IN terminal.

The charge indicator starts flashing. The indicator will stay on when charging is complete.

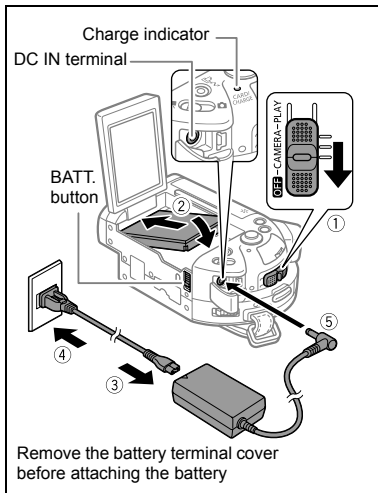

Preparations

Once the battery is fully charged:

1. Disconnect the power adapter from the camcorder.
2. Unplug the power cord from the power outlet and the adapter.

To remove the battery pack:

Hold the BATT. button pressed down to release it, and pull out the battery from the ridge on its bottom part.



Charging, Recording and Playback Times with the BP-208 Battery Pack

The charging time of the BP-208 battery pack is 165 min.

The following recording and playback times are approximate and vary according to the charging, recording or playback conditions.

DC20

Recording Mode		Max. Recording Time	Typical Recording Time*	Playback Time
XP	Viewfinder	65 min.	35 min.	75 min.
	LCD (normal)	60 min.	30 min.	
	LCD (backlight)	60 min.	30 min.	
SP	Viewfinder	70 min.	35 min.	80 min.
	LCD (normal)	70 min.	35 min.	
	LCD (backlight)	65 min.	30 min.	
LP	Viewfinder	80 min.	40 min.	90 min.
	LCD (normal)	75 min.	35 min.	
	LCD (backlight)	75 min.	35 min.	

DC10

Recording Mode		Max. Recording Time	Typical Recording Time*	Playback Time
XP	Viewfinder	75 min.	35 min.	80 min.
	LCD (normal)	70 min.	35 min.	
	LCD (backlight)	70 min.	35 min.	
SP	Viewfinder	80 min.	40 min.	90 min.
	LCD (normal)	80 min.	40 min.	
	LCD (backlight)	75 min.	40 min.	
LP	Viewfinder	95 min.	45 min.	100 min.
	LCD (normal)	90 min.	45 min.	
	LCD (backlight)	85 min.	40 min.	

* Approximate times for recording with repeated operations such as start/stop, zooming, power on/off.

Using a Household Power Outlet

Connect to a household power outlet to use the camcorder without worrying about the battery power. You can keep the battery pack attached; the battery power will not be consumed.

1. Turn off the camcorder.
2. Connect the power cord to the power adapter.
3. Plug the power cord into a power outlet.
4. Open the terminal cover and connect the power adapter to the camcorder's DC IN terminal.

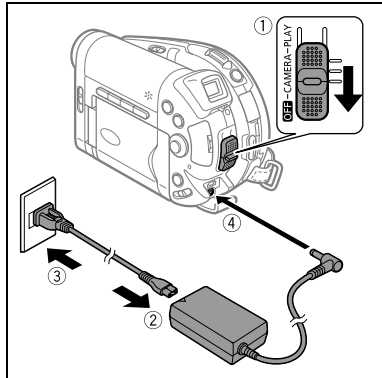

- Turn off the camcorder before connecting or disconnecting the power adapter.
- Do not connect to the camcorder's DC IN terminal or to the power adapter any electrical equipment that is not expressly recommended for use with this camcorder.
- You may hear some noise from the power adapter during use. This is not a malfunction.
- To prevent equipment breakdowns and excessive heating, do not connect the supplied compact power adapter to voltage converters for overseas travels or special power sources such as those on aircraft and ships, DC-AC inverters, etc.
- Do not disconnect and reconnect the power cord while charging a battery pack. Charging may stop. The battery pack may not be charged correctly even if the charge indicator is continuously on. The battery pack may also not be charged correctly when a power outage occurs during charging. Remove the battery pack and attach it back to the camcorder.



- If you connect a faulty power adapter or battery pack, the charge indicator flashes rapidly (approx. twice per second) and charging stops.
- The charge indicator also serves as a rough estimate of the battery charge status.
Continuously on: Battery fully charged.
Flashes rapidly (approx. twice per second): Battery over 50% charged.
Flashes slowly (approx. once per second): Battery less than 50% charged.
- We recommend charging the battery pack in temperatures between 10 °C and 30 °C. Outside the temperature range of 0 °C to 40 °C, the charge indicator flashes rapidly and charging stops.
- A lithium ion battery pack can be charged at any charge state. Unlike conventional battery packs, you do not need to completely use or discharge it before charging.
- To conserve battery power, turn off the camcorder instead of leaving it in record pause mode.
- We recommend that you prepare battery packs 2 to 3 times longer than you think you might need.

Step 2: Preparing the Camcorder

Adjusting the Viewfinder (Dioptric Adjustment)

1. Turn on the camcorder and keep the LCD panel closed.
2. Adjust the dioptic adjustment lever as necessary.

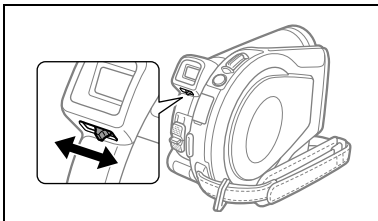

Fastening the Grip Belt

Adjust the grip belt so that you can reach the zoom lever with your index finger, and the start/stop button with your thumb.

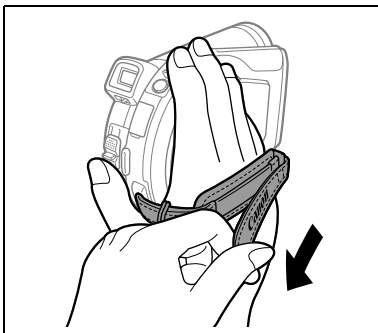

Step 3: Using the Wireless Controller

Inserting the Battery (Lithium Button Battery CR2025)

1. Press the tab in the direction of the arrow and pull out the battery holder.
2. Place the lithium button battery with the + side facing up.
3. Insert the battery holder.

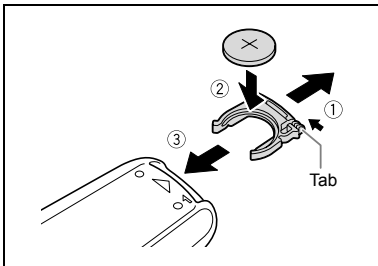

Using the Wireless Controller

Point the controller at the camcorder's remote sensor when you press the buttons.

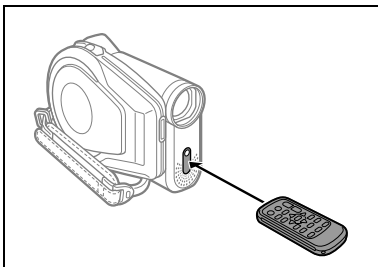

- The wireless controller may not work properly when the remote sensor is situated under strong light sources or direct sunlight.
- If the wireless controller does not work, check that the remote sensor is not set to [OFF] (OFF) (□ 81).
- When the camcorder cannot be operated with the wireless controller, or when it can only be operated at a very close range, replace the battery.

Step 4: Adjusting the LCD Screen

Rotating the LCD Panel

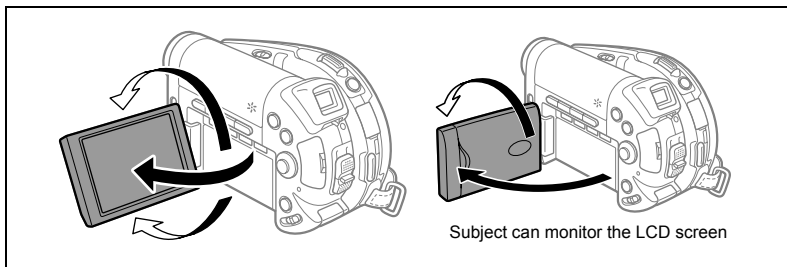

Open the LCD panel 90 degrees.

- You can rotate the panel downward by 90 degrees.
- You can rotate the panel by 180 degrees toward the lens (allowing the subject to monitor the LCD screen while you use the viewfinder).



Rotating the panel by 180 degrees is also useful if you wish to include yourself when recording with the self-timer.

LCD Backlight

You can switch the brightness of the LCD screen between normal and bright by pressing the BACKLIGHT button. This is useful when recording outdoors.

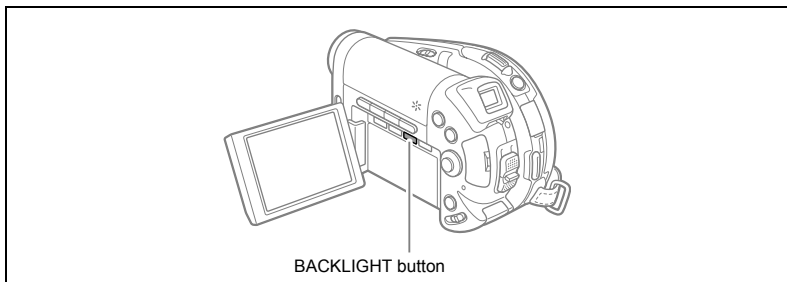

Press the BACKLIGHT button.

Repeatedly pressing the BACKLIGHT button will toggle the LCD brightness on and off.



- This setting does not affect the brightness of the recording or the viewfinder screen.
- Using the brighter LCD setting will shorten the effective usage time of the battery.

Step 5: Changing the Display Language

The language used in the camcorder displays and menu items can be changed to German, Spanish, French, Italian, Russian, Simplified Chinese, Traditional Chinese, Korean or Japanese.

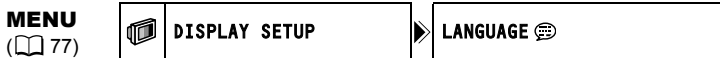

1. Turn on the camcorder (CAMERA or PLAY).
2. Press the MENU button.

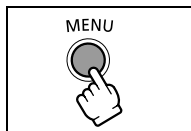

3. Use the omni selector (▲▼) to select the [DISPLAY SETUP] menu and press (SET).
4. Use the omni selector (▲▼) to select the [LANGUAGE 🗨️] option and press (SET).
5. Use the omni selector (▲▼, ◀▶) to select the language desired and press (SET) to select it.
6. Press the MENU button to save the setting and close the menu.

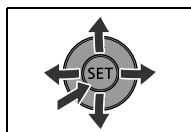

- If you changed the language by mistake, follow the 🗨️ mark next to the menu item to change the setting.
- The displays **SET** and **MENU** that appear on screen while changing the print and direct transfer settings will not change regardless of the language selected.

Step 6: Setting the Time Zone, Date and Time

Setting the Time Zone/Daylight Saving Time

MENU
(77)



1. Turn on the camcorder (CAMERA or PLAY).
2. Press the MENU button to open the menu.

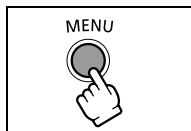

3. Use the omni selector (▲▼) to select the [D/TIME SETUP] menu and press (SET).
4. Use the omni selector (▲▼) to select the [T.ZONE/DST] option and press (SET).

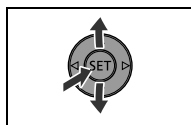

The time zone setting appears. The default setting is Paris.

5. Use the omni selector (▲▼) to select your time zone and press (SET) to save the setting.

To adjust for daylight saving time, select the time zone with the * mark next to the area.

Setting the Date and Time

MENU
(77)



6. Use the omni selector (▲▼) to select the [DATE/TIME] option and press (SET).
The year is displayed in orange.
7. Use the omni selector (▲▼) to select the year and push it to (▶) to move to the month setting.

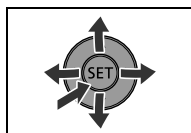

- The next part of the date/time is displayed in orange.
- Set the month, day, hours and minutes in the same way.
- If you do not need to change all settings, you can use the omni selector (◀▶) to move to a specific setting you want to change.

8. Press the MENU button to close the menu and start the clock.

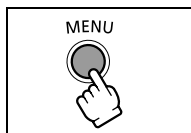



- When you do not use the camcorder for about 3 months, the built-in rechargeable lithium battery may become discharged, and the date/time setting may be erased. In such case, recharge the built-in lithium battery (□ 133) and set the time zone, date and time again.
- You can also change the date format (□ 82).

Time Zones

Once you have set the time zone, date and time, you do not need to reset the clock every time you travel to another time zone. Select the time zone referring to the date and time displayed on the screen.

Time Zones and Difference from GMT/UTC

London	GMT/UTC	Wellington (WELLGTN)	+12
Paris	+1	Samoa	-11
Cairo	+2	Honolulu (HONOLU.)	-10
Moscow	+3	Anchorage (ANCHOR.)	-9
Dubai	+4	Los Angeles (L.A.)	-8
Karachi	+5	Denver	-7
Dacca	+6	Chicago	-6
Bangkok	+7	New York (N.Y.)	-5
Hong Kong (H. KONG)	+8	Caracas	-4
Tokyo	+9	Rio de Janeiro (RIO)	-3
Sydney	+10	Fernando de Noronha (FERNAN.)	-2
Solomon	+11	Azores	-1

Step 7: Inserting a Memory Card

Only miniSD cards can be used with this camcorder.

Inserting the Card

1. Turn off the camcorder.

Make sure the card access indicator is not flashing before you turn the camcorder off.

2. Open the cover.

3. Insert the memory card straight all the way into the memory card slot.

4. Close the cover.

Do not force the cover closed if the memory card is not correctly inserted.

To remove the memory card:

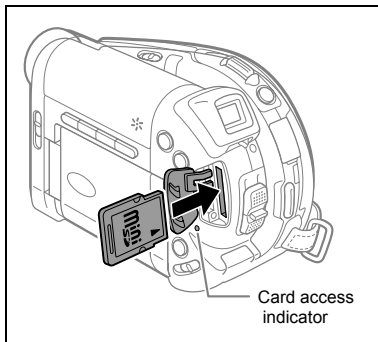

First push the memory card once to release it, and then pull the card out.





- Make sure to initialize all memory cards before using them with this camcorder (p. 95).
- Performance cannot be guaranteed for all miniSD cards.

Step 8: Loading a Disc

Preparations:

Use only 8 cm mini DVD discs marked with the DVD-R  or DVD-RW  logo. Use a soft lens-cleaning cloth to remove any fingerprints, dirt buildup or smudges from the disc surface.

1. Holding the lock button pressed down, move the power switch to CAMERA.
2. Move the  /  switch to the  (MOVIES) position.
3. Push the OPEN button and gently open the disc cover fully until it stops.

- Retract the grip belt under the camcorder so it will not get in the way of the disc cover.
- When there is already a disc in the camcorder it may take a moment after you press the OPEN button for the disc cover to open. Do not force the cover open.

4. Insert the disc with the label side facing out and press its center firmly until it clicks in place.

- When loading a double-sided disc, insert the disc with the side you want to record on facing down.
- Be careful not to touch the recording surface of the disc or the pick up lens.
- To remove the disc, grab its edges with your fingers and gently pull the disc out.

5. Close the disc cover.

Do not force the cover closed if the disc is not correctly inserted and firmly set in place.

When using DVD-R discs (including the supplied blank disc):

You can start recording movies once the record pause  indication appears.

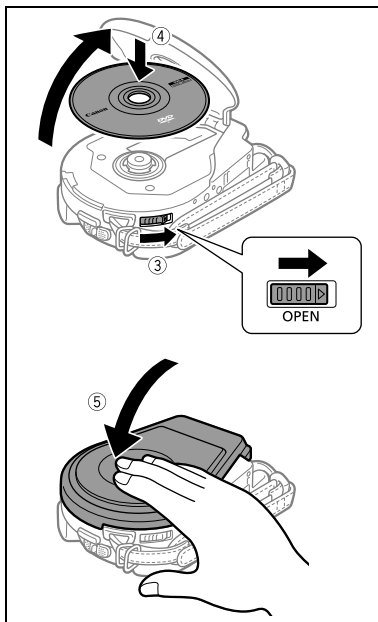

When using a DVD-RW:

You need to initialize the disc before you can start recording. The Disc Initialization screen will appear when a DVD-RW is first inserted. It will not appear when inserting a disc already initialized. In that case, you can start recording once the record pause ●|| indication appears.

- ① Use the omni selector (▲▼) to select the disc specification desired and press (SET) to make the selection. For a comparison between the specifications "VIDEO" and "VR" see *An Introduction to DVDs* (□□ 3).
- ② You will be asked to confirm the disc specification you selected. Use the omni selector (▲▼) to select [YES] and press (SET) to continue, or select [NO] and press (SET) to return and select a different disc specification.
- ③ A confirmation message will appear on the screen. Use the omni selector (▲▼) to select [YES] and press (SET) to start the disc initialization.
- ④ The disc initialization will take approximately one minute. Avoid moving the camcorder while the operation is in progress.
- ⑤ When the disc initialization is completed the camcorder will automatically enter the **CAMERA** mode. You can start recording movies once the record pause ●|| indication appears.



- The Disc Initialization screen may not appear automatically if you operated the camcorder's buttons while the disc recognition was in progress. In that case, initialize the disc using the MENU option (□□ 89).
- The process of recognizing a disc may take a moment. The Ⓢ display will move while the disc is being read. Wait until the camcorder finishes recognizing the disc before you start recording.

Recording Movies

Before You Begin Recording

Make a test recording first to check if the camcorder operates correctly. Since recordings made on a DVD-R cannot be deleted, we recommend you use a DVD-RW disc (commercially available) to make the test recordings.

1. **Holding the lock button pressed down, move the power switch to CAMERA.**
2. **Move the /CAMERA switch to the (MOVIES) position.**
3. **Open the LCD panel and the lens cover (move the lens cover switch down to).**
4. **Press the start/stop button to begin recording.**
 - Press the start/stop button again to pause recording.
 - During the recording and immediately after pausing it, the disc access indicator may go on while the scene is being written on the disc.

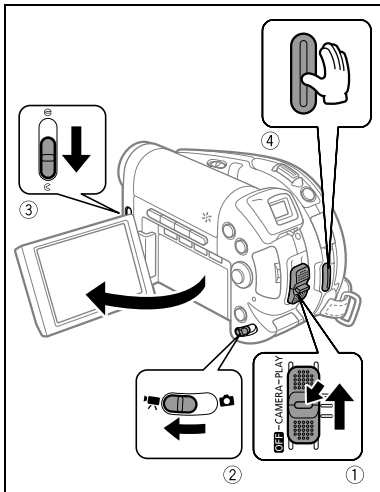

When You Have Finished Recording:

1. **Remove the disc.**
2. **Close the LCD panel and the lens cover (move the lens cover switch to).**
3. **Turn off the camcorder.**
4. **Disconnect the power source.**



Do not turn off the camcorder, change the position of the /CAMERA switch, disconnect the power source, open the memory card/disc cover or remove the memory card/disc while the card access or the disc access indicator is flashing. Doing so could result in data damage.







- The process of recognizing a disc may take a moment. The display will move while the disc is being read. Wait until the camcorder finishes recognizing the disc before you start recording.
- **About the recording time:** The recording mode is set by default as SP (standard play). By changing the recording mode you can change the recording time available on the disc (58).
- When recording in bright places it may be difficult to use the LCD screen. In such case, use the viewfinder instead.
- When recording in very loud places (such as fireworks shows or concerts), sound may become distorted or it may not be recorded at the actual levels. This is not a malfunction.

- In order to save power when the camcorder is powered by a battery pack, the camcorder will automatically shut off if left without any operations for 5 minutes (82). Approximately 30 seconds before the camcorder shuts off, “⚠️ AUTO POWER OFF” appears in the center of the screen. If the camcorder shuts off, move the power switch to OFF and then back to CAMERA or PLAY.
- About the LCD and viewfinder screen: The screens are produced using extremely high-precision manufacturing techniques, with more than 99.99% of the pixels operating to specification. Less than 0.01% of the pixels may occasionally misfire or appear as black or green dots. This has no effect on the recorded image and does not constitute a malfunction.

Reviewing the Last Scene Recorded

In record pause mode:

Press and release the  (record review) button.

- The camcorder plays back the last scene and returns to record pause mode.
- While reviewing the scene, use the omni selector (◀▶) to select the  icon and press () to return to the recording mode. You can also delete the scene by selecting (◀▶) the  icon (85).

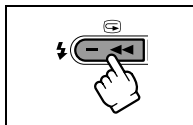

The last scene review is only available if you have not changed operating modes or turned off the camcorder after making the recording.

Recording Still Images

Before using a memory card for the first time, be sure to initialize it with this camcorder (☐ 95).

1. Holding the lock button pressed down, move the power switch to CAMERA.
2. Move the **📷/📺** switch to the **📷** (STILLS) position.
3. Open the LCD panel and the lens cover (move the lens cover switch down to ☺).
4. If necessary, change the media for recording the still images using the procedure described in the next page (☐ 34).

- You can record still images on the memory card or the disc. The default media for still images is the memory card.
- As long as you do not change the recording destination, still images will be recorded to the last selected media.

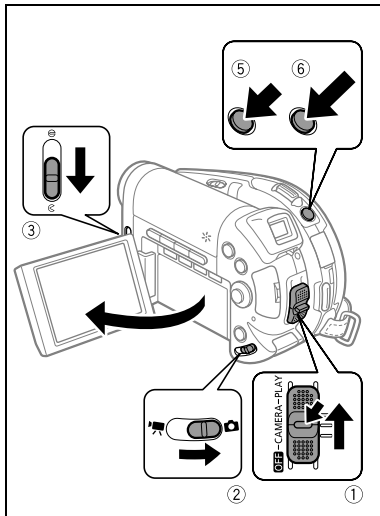

5. Press the PHOTO button halfway.

- Once the focus is automatically adjusted, the camcorder will beep, the **●** mark will turn green and one or more green AF frames appear.
- When you press the PHOTO button on the wireless controller, the still image is recorded immediately.

6. Press the PHOTO button fully.

The **●** mark and the AF frame(s) disappear and you hear a shutter sound.



Do not turn off the camcorder, change the position of the **📷/📺** switch, disconnect the power source, open the memory card/disc cover or remove the memory card/disc while the card access or the disc access indicator is flashing. Doing so could result in data damage.



○ About the focusing frame:



This camcorder uses the 9-point artificial intelligence autofocus (9-point AiAF) that will automatically select the best focusing frames out of nine available, allowing you to focus on subjects even if they are not in the center of the picture (☐ 51).





- If the subject is not suitable for autofocus, **●** turns yellow. Keep the PHOTO button pressed halfway and adjust the focus manually with the omni selector (◀▶).
- In step 5 above, the image may appear out of focus for a moment while the camcorder is focusing.

- When the subject is too bright, "OVEREXP." starts flashing. In such case, use the optional FS-H27U ND filter.
- In order to save power when the camcorder is powered by a battery pack, the camcorder will automatically shut off if left without any operations for 5 minutes (▶ 82). "⚠ AUTO POWER OFF" appears 30 seconds before shutoff. To continue recording, turn the power switch to OFF and then back to CAMERA.

Selecting the Media for the Still Images

You can record still images on the memory card or the disc. The default media for still images is the memory card.

1. Set the camcorder to record or view still images (**CAMERA**  or **PLAY** ).
2. Press the MENU button. Using the omni selector (▲▼) select the [SYSTEM SETUP] menu and press (SET).
3. Select (▲▼) the [MEDIA SEL. ] option and press (SET).
4. Change (▲▼) the setting to [DISC] or [CARD] and press (SET) to save the selection and close the menu.

When recording, the operating mode symbol will change to  (DISC STILLs) or  (CARD STILLs), depending on the media selected. In playback mode, the operating mode symbol will change to  (DISC STILLs) or  (CARD STILLs), respectively.

Zooming

The zoom is available when recording movies or stills. When recording movies (CAMERA ) , in addition to the 10x optical zoom you can also use the 200x digital zoom (78).

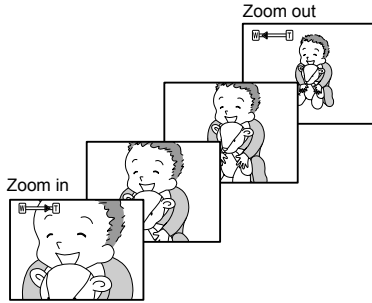

10x Optical Zoom

Move the zoom lever toward **W** to zoom out (wide-angle). Move it toward **T** to zoom in (telephoto).

Press the zoom lever slightly for a slow zoom. Press harder for a faster zoom.

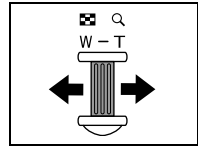

- You can also use the **T** and **W** buttons on the wireless controller. However, in that case you cannot control the zoom speed.
- The zoom speed will be faster in record pause mode.
- Keep a distance of at least 1 m to the subject. At wide-angle, you can focus on a subject as close as 1 cm.

Tips for Better Recording

Holding the Camcorder

For maximum stability, hold the camcorder firmly with your right hand and keep your right elbow pressed against your body. If necessary, support the camcorder with your left hand. Be careful that your fingers do not touch the microphone or lens.



For More Stability

- Lean against a wall



- Place the camcorder on a table



- Lie on your elbow
- Kneel on one knee

- Use a tripod



Lighting

When recording outdoors, we recommend recording with the sun at your back.



- When using a tripod, do not leave the viewfinder exposed to direct sunlight as it may melt (due to concentration of the light by the lens).
- Do not use tripods with fastening screws longer than 5.5 mm. Doing so may damage the camcorder. The camcorder cannot be mounted on tripods with fixed (non-retractable) camera positioning pins.

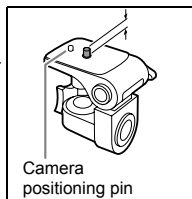

Playing Back Movies

1. Open the LCD panel.

2. Holding the lock button pressed down move the power switch to **PLAY** and slide the **MOVIE/PHOTO** switch to the **MOVIES** position.

The scene index screen appears with the selection frame on the first scene.

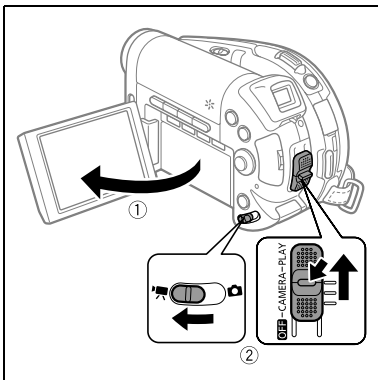

3. Use the omni selector (**▲▼**, **◀▶**) to move the selection frame to the scene you want to play back. Press the **▶/||** button to begin the playback.

- Playback of the scenes recorded on the disc will start from the scene selected.
- When the end of the last movie recorded is reached, playback will stop and the camcorder will return to the scene index screen.

- Press the **+** or **-** button on the camcorder or the **NEXT/PREV.** buttons on the wireless controller to move to the next or previous index page, respectively.

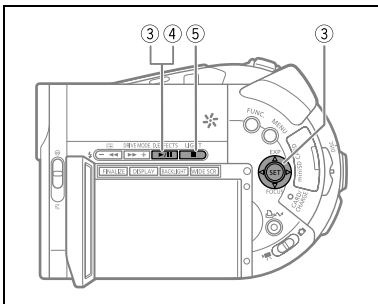

During Playback:

4. Press the **▶/||** button again to pause the playback.

5. Press the **■** button to stop the playback and return to the scene index screen.



○ To use the viewfinder, close the LCD panel.

○ About the screen display: During playback, the recording's time code will be displayed at the upper right corner of the screen in hours : minutes : seconds. You can also choose to display instead the date and time when the scene was recorded and additional recording data (□ 43).

○ Depending on the recording, you might occasionally notice a brief stop of the picture or sound at the point where the scene changes.

Special Playback Modes

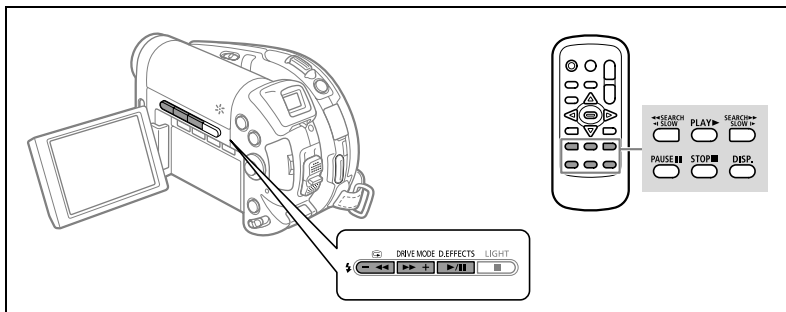

▶/|| (Playback Pause)

During normal playback, press the ▶/|| button on the camcorder or the PAUSE || on the wireless controller.

Skipping Scenes

During normal playback, push the omni selector (▶) to skip to the beginning of the next scene. Push (◀) to return to the beginning of the current scene. Push (◀) again to skip to the beginning of the previous scene.

▶▶ Fast Forward Playback / ◀◀ Fast Reverse Playback

During playback, press the ▶▶ or ◀◀ button on the camcorder or the SEARCH ▶▶ or ◀◀ SEARCH button on the wireless controller. Repeatedly press the button to increase the playback speed. Fast forward playback will start at 1.5x the normal playback speed and will increase to 5x, 15x and 25x normal speed with each press of the button. Fast reverse playback will start at 2.5x the normal playback speed and will increase to 5x, 15x and 25x normal playback speed with each press of the button. Press the ▶/|| button to return to normal playback.

SLOW ▶ Slow Forward Playback / ◀ SLOW Slow Reverse Playback

During playback pause, press the ▶▶ or ◀◀ button on the camcorder or the SLOW ▶ or ◀ SLOW button on the wireless controller. Repeatedly press the button to increase the playback speed. Playback will start at 1/16 the normal playback speed and will increase to 1/8, 1/4 and 1/2 the normal speed with each press of the button. Press the ▶/|| button to return to playback pause.



- Except for fast playback at 1.5x the normal speed, there is no sound during special playback modes.
- The picture may become distorted during some special playback modes.
- Slow playback is not available with discs recorded in VIDEO mode (DVD-R or DVD-RW).
- During the playback of a Photomovie scene, even though the display may change according to the fast forward/reverse playback, the actual playback speed will not change.

Viewing Still Images

1. Open the LCD panel.
2. Holding the lock button pressed down move the power switch to **PLAY** and slide the **▶/📷** switch to the **📷 (STILLS)** position.
3. If necessary, change the media for the still images using the procedure described in the *Recording Still Images* section (📖 34).
 - You can show the still images on the memory card or the disc. The default media for still images is the memory card.
 - As long as you do not change the media selection, the camcorder will show the still images recorded on the media that was selected last.

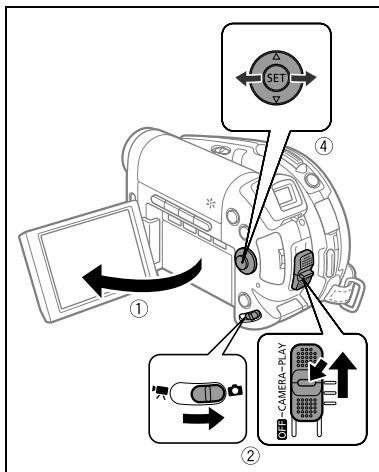

4. Use the omni selector (**◀▶**) to move between images.

Slide Show

FUNC.
(📖 57)

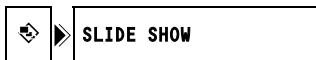

1. Press the **FUNC.** button.
2. Use the omni selector (**▲▼**) to select [**SLIDE SHOW**] and press (**SET**) to make the selection.
3. Use the omni selector (**◀▶**) to select [**START**] and press (**SET**) to start the slideshow.
 - Images are played back one after another.
 - Press the **■** button to stop the slide show.

Index Screen

1. Move the zoom lever toward **W**.
The stills index screen appears with the first six still images.
2. Use the omni selector (**▲▼**, **◀▶**) to select an image.
 - Move the “**☞**” to the image you wish to view.
 - You can switch between index pages by pressing the **+** or **-** button.
3. Move the zoom lever toward **T**.
The index screen closes and the selected image is displayed.

Image Jump Function

You can also quickly locate a specific image without having to browse all of them one by one. The number in the upper right of the screen indicates the number of the current image out of the total number of images.

Push the omni selector (◀▶) and keep it pressed down.

Image numbers will quickly run in sequence. When you release the omni selector the image corresponding to the number selected will be displayed.







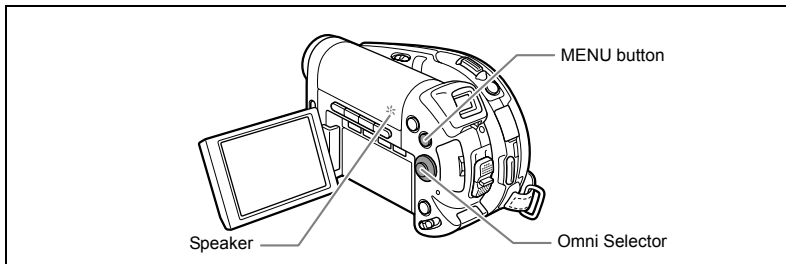

- The following may not be displayed correctly: Images not recorded with this camcorder, images edited on or uploaded from a computer (except for the sample images for the Card Mix function), and images whose file names have been changed.
- Do not turn off the camcorder, change the position of the  switch, disconnect the power source, open the memory card/disc cover or remove the memory card/disc while the card access or the disc access indicator is flashing. Doing so could result in data damage.

Adjusting the Volume

While playing a movie (): If you use the LCD screen for playback the camcorder will play the sound using the built-in speaker. If you close the LCD panel the sound will be muted.



From the scene index screen or during playback:

1. Press the **MENU** button.
2. Use the omni selector () to select the [SYSTEM SETUP] menu and press ().
3. Use the omni selector () to select the [VOLUME] option and press ().
4. Adjust () the volume as desired and press ().

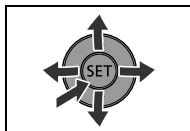

The menu symbol will show the volume level selected. When you turn off the volume completely  will appear instead.

5. Press the **MENU** button to save the setting and close the menu.

Magnifying the Image



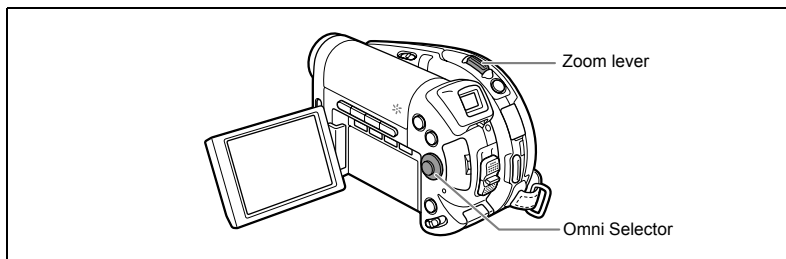

While viewing a still image (**PLAY** ), the playback image can be magnified up to 5 times.



1. Move the zoom lever toward **T**.

- The image is magnified by 2 times and a frame appears indicating the position of the magnified area.
- To further enlarge the image, move the zoom lever toward **T**. To reduce the magnification to less than 2x, move the zoom lever toward **W**.
-  will appear for images that cannot be enlarged.

2. Select the part of the image to be magnified with the omni selector.

- Use the omni selector (  ,  ) to move the frame to the part of the image you want to see enlarged.
- To cancel the magnification, move the zoom lever toward **W** until the frame disappears.

Displaying Additional Recording Data

The camcorder keeps a data code containing the recording date and time and other camera data such as shutter speed and exposure (f-stop). You can select the data to be displayed when playing back a movie (**PLAY**) or viewing a still image (**PLAY**).

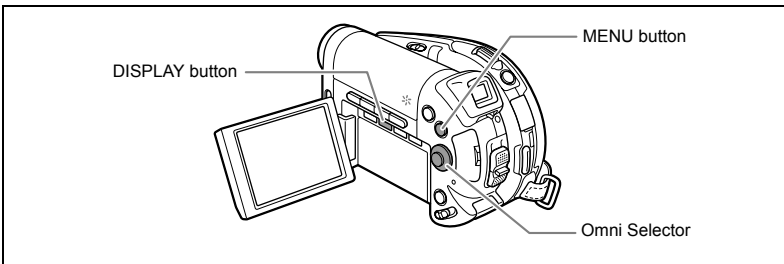

Selecting the Date/Time Display Combination

MENU
(77)



1. Press the **MENU** button.
2. Use the omni selector (**▲▼**) to select the [DISPLAY SETUP] menu and press (**SET**).
3. Use the omni selector (**▲▼**) to select the [DATA CODE] option and press (**SET**).
4. Use the omni selector (**▲▼**) to select the data combination desired and press (**SET**) to select it.

In **PLAY** mode you can only choose to display the recording date, the time or both.

5. Press the **MENU** button to save the setting and close the menu.
6. While playing back a movie or viewing a still image, press the **DISPLAY** button to turn on the data code display.

Repeatedly pressing the **DISPLAY** button will turn the on-screen displays on and off in the following sequence:

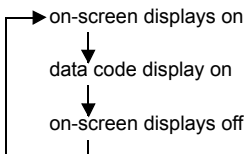

Using the Recording Programs

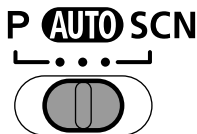

AUTO Auto

The camcorder adjusts focus, exposure and other settings automatically, allowing you to just point and shoot.



P

P Program AE (📖 46)

Tv Shutter-Priority AE (📖 47)

Av Aperture-Priority AE (📖 48)

SCN

Portrait

The camcorder uses a large aperture, achieving a focus on the subject while blurring other distracting details.



Snow

Use this mode to record in bright ski resorts. It prevents the subject from being underexposed.



Spotlight

Use this mode to record spotlight scenes.



Sports

Use this mode to record sports scenes such as tennis or golf.



Beach

Use this mode to record on a sunny beach. It prevents the subject from being underexposed.



Fireworks

Use this mode to record fireworks.



Night

Use this mode to record in dimly lit places.



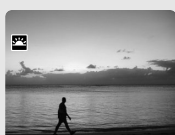

Sunset

Use this mode to record sunsets in vibrant colors.



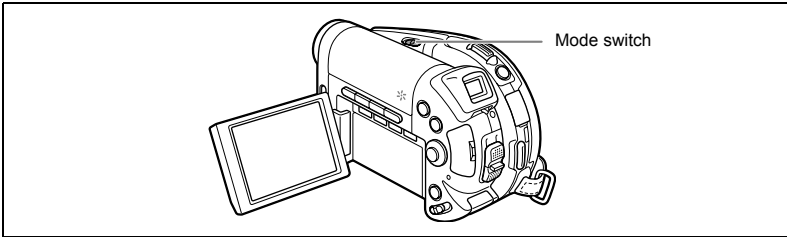

Selecting the Recording Program

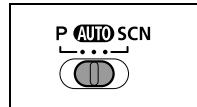

Set the camcorder to a recording mode (**CAMERA** · ) or (**CAMERA** · ) and use the mode switch to choose one of the following recording program categories:





AUTO: Automatic mode

P: Program AE (P) () 46), Shutter-Priority AE (Tv) () 47) or Aperture-Priority AE (Av) () 48) can be selected.

SCN (Scene): Portrait, Sports, Night, Snow, Beach, Sunset, Spotlight, or Fireworks can be selected () 44).

To select a specific recording program after choosing **P** or **SCN**:

1. Press the **FUNC.** button.
2. Select () the symbol of the program currently activated from the left side column.
3. Select () the recording program desired.
4. Press the **FUNC.** button to make the selection and close the menu.

The symbol of the selected recording program will appear.



- Do not change the recording program during recording as the brightness of the image may change abruptly.
- Portrait:
 - The blur effect of the background increases the more you zoom in (T).
 - The picture may not appear smooth when played back.
- Sports:
 - The picture may not appear smooth when played back.
- Night:
 - Moving subjects may leave a trailing afterimage.
 - Picture quality may not be as good as in other modes.
 - White points may appear on the screen.
 - Autofocus may not work as well as in other modes. In such case, adjust the focus manually.
- Snow/Beach:
 - The subject may become overexposed on cloudy days or in shaded places. Check the image on the screen.
 - The picture may not appear smooth when played back.
- Fireworks:
 - To avoid camcorder shake, we recommend using a tripod. Make sure to use a tripod especially when recording still images, as the shutter speed slows down.

P Using the Program AE Mode

The camcorder automatically adjusts the aperture and shutter speed according to the subject to achieve the best exposure conditions. In Program AE mode, you can point and shoot as in Auto mode, while still enjoying the option to manually adjust some settings.

1. Set the camcorder to a recording mode



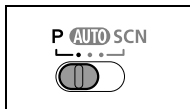

(**CAMERA** ·  or **CAMERA** · ) and move the mode switch to **P**.



2. From the FUNC. menu, select the **P (PROGRAM AE)** mode (45).



If the optimal exposure cannot be obtained, try the following actions.



- Manually adjust the exposure ( 49).
- Change the metering method ( 60).
- **DC20** Use the flash ( 54).
- **DC20** Use the mini video light ( 53).

Tv Using the Shutter-Priority AE Mode

You can select a shutter speed, and the camcorder automatically sets the aperture setting most appropriate for the subject.

Select a high shutter speed for recording fast moving subjects, and a slow shutter speed to add a motion blur to moving objects, enhancing the feel of movement of the image.

Guidelines for selecting the shutter speed

 CAMERA	 CAMERA	
1/6, 1/12, 1/25	1/2, 1/3, 1/6, 1/12, 1/25	For recording subjects in dark places.
1/50	1/50	For general recordings.
1/120	1/120	For recording indoor sports scenes.
1/250, 1/500, 1/1000	1/250, 1/500	For recording from within a car or trains, or recording moving subjects such as roller coasters.
1/2000	-	For recording outdoor sports such as golf or tennis on sunny days.

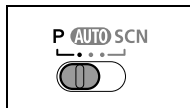

1. Set the camcorder to a recording mode ( or ) and move the mode switch to P.



2. From the FUNC. menu, select the Tv (SHUTTER-PRIO. AE) mode ( 45).

3. Press ().

The denominator of the current shutter speed will be displayed with a blue background.

4. Change () the shutter speed and press () to save the setting.

- The denominator of the shutter speed selected will be displayed.
- The aperture value is adjusted automatically.



- The shutter speed denominator flashes when the selected shutter speed is not appropriate for the recording condition. In such case, readjust the shutter speed.
- When using a slow shutter speed in dark places, you can obtain a brighter image, but the image quality may be lower, and the autofocus may not work well.
- Do not point the camcorder directly at the sun when the shutter speed is set to 1/1000 or higher.
- The image may flicker when recording with high shutter speeds.

Av Using the Aperture-Priority AE Mode

You can select an aperture value, and the camcorder automatically sets the shutter speed most appropriate for the subject. Use low aperture values (large aperture) to blur the background for a portrait, or high aperture values (small aperture) to achieve a broad depth of field for recording landscapes.

Aperture values: 1.8, 2.0, 2.4, 2.8, 3.4, 4.0, 4.8, 5.6, 6.7, 8.0, 9.5, 11, 14, 16

1. Set the camcorder to a recording mode

( or ) and move the mode switch to P.

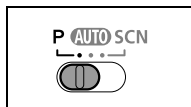

2. From the FUNC. menu, select the Av (APERTURE-PRIO. AE) mode (45).

3. Press ().

The current aperture value will be displayed with a blue background.

4. Change () the aperture value and press () to save the setting.

- The aperture value selected will be displayed.
- The shutter speed is adjusted automatically.
- The aperture becomes smaller the bigger the aperture value.



- The aperture value flashes when the selected aperture is not appropriate for the recording condition. In such case, readjust the aperture.
- Available aperture values vary depending on the zoom position.

Manually Adjusting the Exposure

Adjust the exposure when a subject is underexposed (for example, when backlit subjects appear too dark in the image) or overexposed (for example, when recording subjects under very strong light and they appear too bright or glaring in the image).

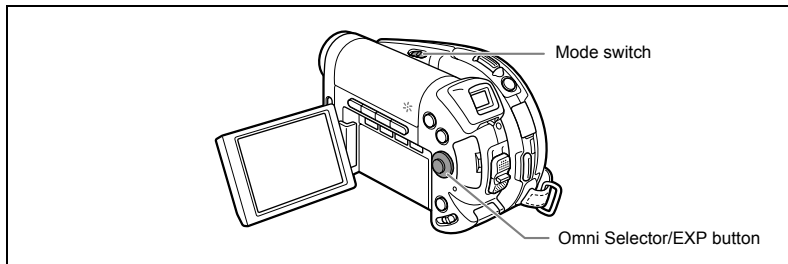

Exposure Lock

1. Set the camcorder to a recording mode (**CAMERA · [Fireworks icon]** or **CAMERA · [Camera icon]**) and move the mode switch to a position other than **AUTO**.
Exposure cannot be adjusted in the Fireworks recording program (SCN).
2. Push the omni selector (**▲**) towards EXP.
 - The exposure adjustment indicator **◀—|—▶** and the neutral value "±0" appear on the screen.
 - If you operate the zoom during exposure lock, the brightness of the image may change.
 - Pushing the omni selector (**▲**) again will cancel the exposure lock and return the camcorder to the previous setting.

Exposure Adjustment

During exposure lock:

Adjust (**◀▶) the brightness of the image as required.**

The adjustment range depends on the brightness of the picture at the time you locked the exposure.

Manually Adjusting the Focus and Changing the Focusing Mode

Autofocus may not work well on the following subjects. In such case, focus manually.

Reflective surfaces



Subjects with low contrast or without vertical lines



Fast Moving Subjects



Through dirty or wet windows



Night Scenes

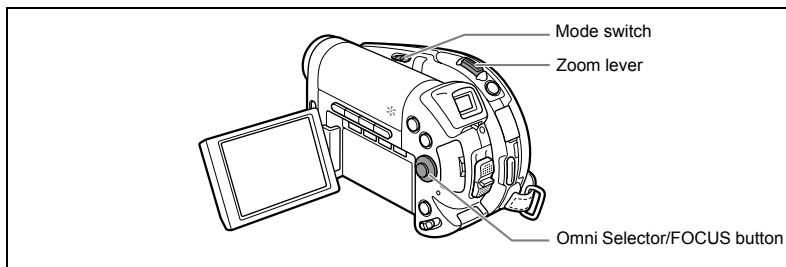

1. Set the camcorder to a recording mode (or) and move the mode switch to a position other than **AUTO**.
2. Adjust the zoom.
3. Push the omni selector () towards **FOCUS**.
"MF" appears.
4. Adjust () the focus as required until the image appears focused.
Pushing the omni selector () again will return to autofocus.



- The camcorder will automatically return to autofocus when you move the mode switch to **AUTO**.
- Readjust the focus when you have turned off the camcorder.

Infinity Focus

Use this function when you wish to focus on faraway subjects such as mountains or fireworks.

After step 2 above, hold the omni selector pushed () towards FOCUS for more than 2 seconds.

"∞" appears.



- If you operate the zoom or the omni selector () during infinity focus, "∞" changes to "MF" and the camcorder returns to manual focusing mode.

Changing the Focusing Mode

You can change the AF (autofocus) frame selection mode.

9 Point AiAF (Auto selection)	Depending on the shooting conditions, one or more AF frames out of the nine frames available are automatically selected and focused on.
Center point	Out of the nine frames available, the center AF frame is selected to focus. This is convenient for making sure the focus is exactly where you want it.

1. Set the camcorder to record still images () and move the mode switch to a position other than .

- The setting differs depending on the position of the mode switch.
 : 9 Point AiAF
P , **SCN**: 9 Point AiAF or Center point
- The focusing mode cannot be changed in the Fireworks recording program (SCN).

2. Select () the focusing mode.

- 9 Point AiAF: four framing corners will appear on the screen when making the selection; the frame corners do not appear in the regular recording mode.
- Center point: a single focusing frame appears in the center of the screen when making the selection; the frame will appear in white in the regular recording mode.



You cannot select the AF frame while recording in Stitch Assist mode.

Recording in Widescreen (16:9 Aspect Ratio)

The camcorder uses the full width of the CCD providing high-resolution 16:9 recording.

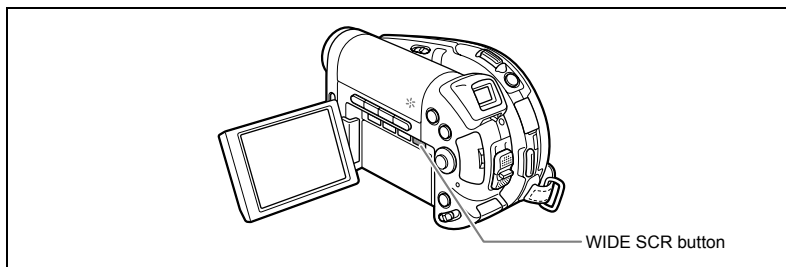

1. Set the camcorder to record movies ().

2. Press the WIDE SCR button.

- “WIDE” appears and the screen changes to the “letterbox” display.
- Repeatedly pressing the WIDE SCR button will toggle the screen between the Widescreen (16:9) and 4:3 aspect ratios.



- Widescreen is not available when recording in LP mode if the disc specification is VIDEO mode (DVD-R or DVD-RW). Selecting the LP recording mode will cancel the 16:9 aspect ratio.
- If you turn off the image stabilizer, you can achieve a wider horizontal angle of view.

DC20 Using the Mini Video Light

You can turn on the mini video light (assist lamp) at any time regardless of the recording program.

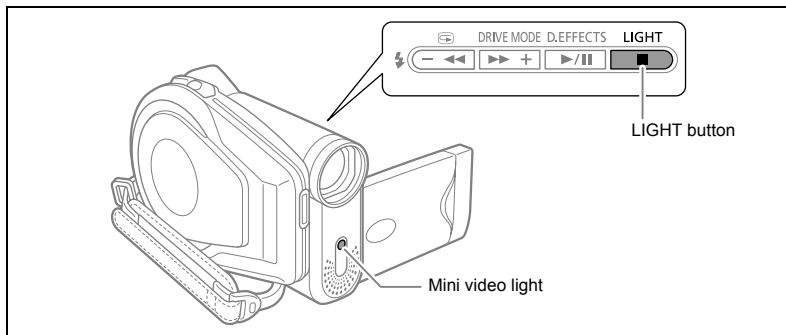

Set the camcorder to a recording mode (**CAMERA · ** or **CAMERA · **) and press the LIGHT button.

- “” appears on the screen.
- Repeatedly pressing the LIGHT button will turn the mini video light on and off.



- Do not point the mini video light at people while they are driving.
- Do not stare at the mini video light for a long time.
- Do not use the mini video light close to people's eyes.

DC20 Using the Flash

You can use the built-in flash for recording still images in dark places. The flash is equipped with the red-eye reduction function.

⚡ ^A (auto)	The flash fires automatically according to the brightness of the subject.
⊙ (red-eye reduction, auto)	The flash fires automatically according to the brightness of the subject. The assist lamp lights up to reduce the red-eye effect.
⚡ (flash on)	The flash always fires.
⊕ (flash off)	The flash does not fire. Use this setting in places where flash photography is prohibited.

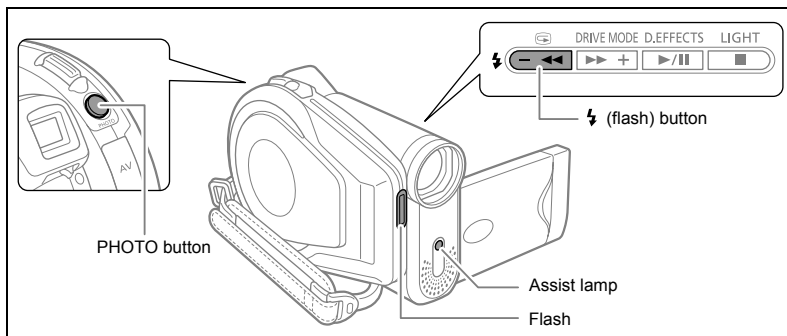

1. Set the camcorder to record still images (**CAMERA**) and select a recording program other than Fireworks (SCN).
2. Press the ⚡ (flash) button.
 - Repeatedly pressing the ⚡ button will cycle between the flash modes.
 - The symbol of the selected flash mode appears on the screen. “⚡^A” disappears after 4 seconds.
3. Press the PHOTO button, first halfway to activate the autofocus and then fully to record the still image.

The flash fires according to the flash mode selected and the recording conditions.



- Do not fire the flash close to people's eyes.
- Do not fire the flash at people while they are driving.
- Do not fire the flash with the flash bulb covered with your hand.



- The practical range of the flash is approx. 1 to 2 m. The range depends upon the recording conditions.
- The range of the flash decreases in continuous shooting mode.
- For the red-eye reduction to be effective, the subject needs to look at the assist lamp. The degree of reduction depends on the distance and on each individual.
- The flash will not fire in the following cases:
 - When you press the EXP button in ⚡^A (auto) or ⊙ (red-eye reduction) mode.
 - During auto exposure bracketing.

- We recommend not using the flash when the optional Wide-converter or Tele-converter is attached. Their shadows appear on the screen.
- The flash mode cannot be selected when the exposure is locked, or after the first still image in Stitch Assist mode.
- The red-eye reduction mode cannot be used in Stitch Assist mode.

- **About the AF-Assist Lamp:**

While you press the PHOTO button halfway, if the subject is too dark the assist lamp may light up briefly in order to enable the camcorder to focus more accurately (AF-assist lamp).

- The camcorder may not be able to focus even though the AF-assist lamp is on.
- The brightness of the AF-assist lamp could be an inconvenience. Consider turning off the AF-assist lamp in public places such as restaurants or theaters.

Using the Self-Timer

The self-timer can be used when recording still images or movies.

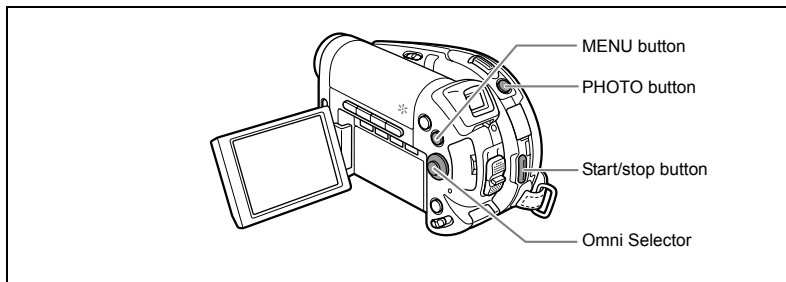

MENU
(77)



1. Set the camcorder to a recording mode (or).
When recording movies set the camcorder to record pause.
2. Press the **MENU** button.
3. Using the omni selector (,) select the [CAMERA SETUP] menu and then select the [SELF TIMER] option.
4. Set () it to [ON] and press () to save the setting.
5. Press the **MENU** button to close the menu.
“” appears.

When recording a still image:

6. Press the **PHOTO** button, first halfway to activate the autofocus and then fully to record the still image.
The camcorder will record the still image after a 10-second countdown (2 seconds when using the wireless controller). The countdown appears on the screen.

When recording a movie:

6. Press the **start/stop** button.
The camcorder starts recording after a 10-second countdown (2 seconds when using the wireless controller). The countdown appears on the screen.



- To cancel the self-timer, set the [SELF TIMER] option in the [CAMERA SETUP] menu to [OFF]. Once the countdown has begun, you can also press the start/stop button (when recording movies) or the PHOTO button (when recording still images) to cancel the self-timer.
- The self-timer will be canceled if you turn off the camcorder.

Changing Settings with the FUNC. Button

Many of the camcorder's functions can be adjusted from the menu that opens after pressing the FUNC. button. For a list of the settings that can be changed using this menu, see *Available Settings List (FUNC.)* (□ 58).

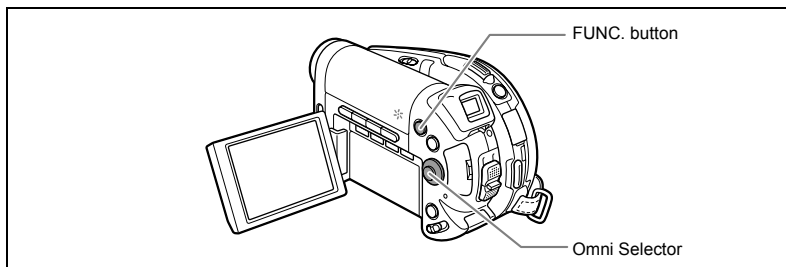

1. Press the FUNC. button.

- The menu appears.
- The symbols of the current settings are displayed on the left side column.

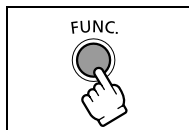

In the recording modes (**CAMERA** · or **CAMERA** ·):

2. Use the omni selector (▲▼) to select the function you want to change.

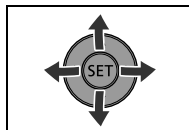

3. Use the omni selector (◀▶) to move through the available options at the bottom bar.

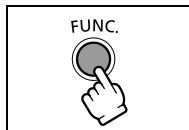

4. Press the FUNC. button to save the settings and close the menu.

- The symbol of the selected option will be displayed.
- Refer to the following pages for further details on setting the [SET] option for the white balance function (□ 61), the [CUSTOM] option for the image effect function (□ 63), or the [MULTI-S] option for the digital effect function (□ 71).



- The symbols of functions not available appear grayed out on the left side column.
- Pressing the FUNC. button at any time closes the menu.
- Refer to the relevant sections of *Editing Functions* (□ 83) for further details on the available functions when playing back movies (**PLAY** ·) or viewing still images (**PLAY** ·).

Available Settings List (FUNC.)









Available menu items vary depending on the operation mode. Default settings are in boldface text. For details on each function, see the reference page.

Menu Items	Setting Options	CAMERA		PLAY		Book icon
Recording programs	P PROGRAM AE, Tv SHUTTER PRIORITY AE, Av APERTURE PRIORITY AE	○	○			44
	PORTRAIT, SPORTS, NIGHT, SNOW, BEACH, SUNSET, SPOTLIGHT, FIREWORKS					
Light metering mode	EVALUATIVE , CENT.WEIGHT.AVERAGE, SPOT		○			60
White balance	AUTO , DAYLIGHT, SHADE, CLOUDY, TUNGSTEN, FLUORESCENT, FLUORESCENT H, SET	○	○			61
Image effect	IMAGE EFFECT OFF , VIVID, NEUTRAL, LOW SHARPENING, SOFT SKIN DETAIL, CUSTOM	○	○			63
Drive mode	SINGLE , CONT.SHOOT., HISPEED CONT.SHOOT., AEB, STITCH AST		○ ¹			64 66
	D.EFFECT OFF , FADER, EFFECT, MULTI-S, CARD MIX	○				68
	D.EFFECT OFF , BLK&WHT		○			
Recording mode	XP HIGH QUALITY, SP STANDARD PLAY, LP LONG PLAY	○				-
Still image recording	STILL I. REC OFF , S FINE/640x480, S NORMAL/640x480	○				76
Still image size/quality	DC20 L 1632x1224, M 1280x960, S 640x480		○			74
	DC10 L 1280x960, S 640x480					
	SUPER FINE , FINE , NORMAL					

¹ This option is available only when recording still images on the memory card .

Recording mode: You can choose between XP (high quality), SP (standard play) or LP (long play).

- Recording in LP mode gives you a longer recording time; however, depending on the condition of the disc (long usage, imperfections, etc.) the picture and sound recorded in LP mode may be distorted. We recommend using the XP or SP mode for important recordings.
- Approximate recording times with the supplied DVD-R blank disc are as follows:
XP (high quality): 20 min., SP (standard play): 30 minutes, LP (long play): 60 minutes.
The camcorder uses a variable bit rate (VBR) when encoding the video data so the actual recording times will vary depending on the content of the scenes.
- Depending on the recording mode, you might occasionally notice a brief stop of the picture or sound at the point where the scene changes.

Menu Items	Setting Options	CAMERA		PLAY		Page No.
						
Image erase	-		<input type="radio"/> ¹		<input type="radio"/>	92
Slide show	CANCEL, START				<input type="radio"/>	39
Convert to scene	-				<input type="radio"/>	87
Divide	-			<input type="radio"/>		84
Delete	-			<input type="radio"/>		85
Move	-			<input type="radio"/> ²		83
Add	ALL SCENES, ONE SCENE, CANCEL			<input type="radio"/> ³		83
Copy [ → ]	-				<input type="radio"/> ⁴	90
Copy [ → ]	-				<input type="radio"/> ⁵	90
Protect	OFF, ON		<input type="radio"/> ¹		<input type="radio"/> ⁴	94
Print order	0 ~ 99 COPIES				<input type="radio"/> ⁴	120
Transfer order	OFF, ON				<input type="radio"/> ⁴	111

¹ This option appears only when pressing the FUNC. button immediately after recording a still image.

² This option is available only from the playlist index screen.



³ This option is available only from the original movies index screen.

⁴ This option is available only for still images recorded on the memory card .

⁵ This option is available only for still images recorded on the disc .

Changing the Metering Method



You can select the light metering mode.

 EVALUATIVE	Appropriate for standard shooting conditions, including backlit scenes. The camcorder divides images into several zones for light metering and evaluates complex lighting conditions in order to achieve the optimal exposure of the subject.
 CENT.WEIGHT.AVERAGE	Averages the light metered from the entire screen, giving more weight to the subject in the center.
 SPOT	Meters the area within the spot AE point frame. Use this setting for adjusting the exposure to match the subject in the center of the screen.

FUNC.
( 57)



1. Set the camcorder to record still images (**CAMERA** ) and move the mode switch to **P**.
2. Press the **FUNC.** button.
3. First, select (**▲▼**) the current light metering symbol from the left side column and then select (**◀▶**) the desired option from the bottom bar.
4. Press the **FUNC.** button to save the setting and close the menu.

If you select [ SPOT], the spot AE frame “” will appear in the center of the screen.

Setting the White Balance

You can choose one of the preset settings to reproduce colors more accurately, or set a custom white balance to obtain the setting best suited to your specific recording conditions.

AWB AUTO	Settings are automatically set by the camcorder.
☀ DAYLIGHT	For recording outdoors on a bright day.
☁ SHADE	For recording in shaded places.
☁ CLOUDY	For recording on a cloudy day.
⚡ TUNGSTEN	For recording under tungsten and tungsten type (3-wavelength) fluorescent lighting.
☀ FLUORESECENT	For recording under warm white, cool white or warm white type (3-wavelength) fluorescent lighting.
☀ FLUORESCENT H	For recording under daylight or daylight type (3-wavelength) fluorescent lighting.
📷 SET	Use the custom white balance setting to make white subjects appear white under colored lighting.

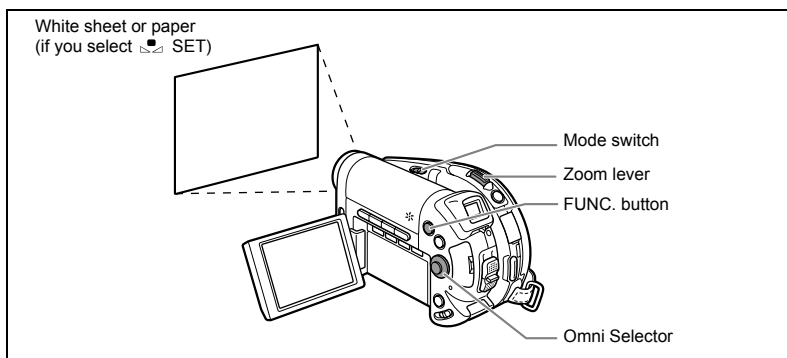

1. Set the camcorder to a recording mode (**CAMERA** · 📹 or **CAMERA** · 📷) and move the mode switch to P .
2. Press the FUNC. button.
3. First, select (▲▼) the current white balance symbol from the left side column and then select (◀▶) the desired option from the bottom bar.
4. If you select the custom white balance [📷 SET]: Point the camcorder at a white object, zoom in until it fills the whole screen and press (⊞).
 - Keep the camcorder zoomed at the white object until step 5 is completed.
 - 📷 flashes and stops flashing when the adjustment is complete.

5. Press the FUNC. button to save the setting and close the menu.







The symbol of the selected setting appears.











- In general, we recommend using the [AUTO] setting for outdoor scenes.
- Depending on the type of fluorescent light, optimal color balance may not be obtained with [FLUORESCENT] or [FLUORESCENT H]. If the color looks unnatural on the screen, adjust it using [AUTO] or [SET].
- The camcorder retains the custom white balance setting even if you turn it off.
- If you want to use again the last customized white balance setting, after selecting the option [SET] in step 3 above, skip step 4 and press the FUNC. button without pressing (SET).
- When you have set the custom white balance:
 - Depending on the light source, “ ” may keep flashing. The result will still be better than with the auto setting.
 - Reset the white balance when the lighting condition changes.
 - Turn off the digital zoom.
- Custom white balance may provide better results in the following cases:
 - Changing lighting conditions
 - Close-ups
 - Subjects in a single color (sky, sea or forest)
 - Under mercury lamps and certain types of fluorescent lights

Applying Image Enhancing Effects

You can record with different color saturation and contrast effects.

 IMAGE EFFECT OFF	Records with no image enhancing effects.
 VIVID	Emphasizes the contrast and color saturation.
 NEUTRAL	Tones down the contrast and color saturation.
 LOW SHARPENING	Records subjects with softened outlines.
 SOFT SKIN DETAIL	Softens the details in the skin tone area for a more complimentary appearance.
 CUSTOM	Allows you to adjust the brightness, contrast and sharpness of the image.





1. Set the camcorder to a recording mode ( or ) and move the mode switch to P .
2. Press the FUNC. button.
3. First, select () the current image effect symbol from the left side column and then select () the desired option from the bottom bar.
4. If you select the custom image effect [ CUSTOM]: Press (). Select () the custom setting option (brightness, contrast, sharpness and color depth) and adjust () each setting as desired. Press () again to save the customized adjustments.
5. Press the FUNC. button to save the setting and close the menu.
The symbol of the selected setting appears.





[SOFT SKIN DETAIL]: To obtain the best effect, use this function when recording a person in close-up. Note that areas similar to the skin color may lack in detail.

Continuous Shooting and Exposure Bracketing

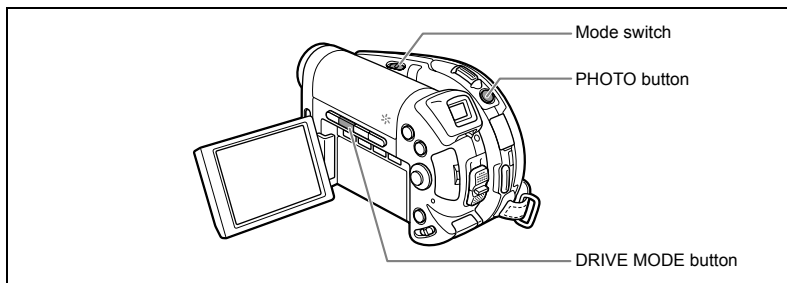
<input type="checkbox"/> Single	Records a single still image when you press the PHOTO button.
 Continuous Shooting  High-Speed Continuous Shooting	Captures a quick series of still images while you press the PHOTO button. For the number of frames per second, refer to the table on the next page.
 AEB (Auto Exposure Bracketing)	The camcorder records a still image in three different exposures (dark, normal, light in 1/2 EV steps), allowing you to choose the shot you like the best.



1. Set the camcorder to record still images on the card ( / ) and move the mode switch to a position other than **AUTO**.

If you are recording stills on the disc (), change the media for the still images ( 34).

2. Press the **DRIVE MODE** button repeatedly to cycle between the drive modes.
3. Press the **PHOTO** button halfway.
4. **Continuous Shooting/High-Speed Continuous Shooting: Press the PHOTO button fully and hold it pressed down.**

A series of still images will be recorded as long as you hold the PHOTO button pressed.

Auto Exposure Bracketing: Press the PHOTO button fully.

Three still images in different exposures are recorded on the memory card.



- The drive mode can also be selected from the FUNC. menu ( 57).
- When the FUNC. menu is being displayed, the **DRIVE MODE** button cannot be used.

- Maximum number of continuous shots at one time:

Still Image Size	Frames per Second			Maximum Number of Continuous Shots
	Normal speed	High speed	DC20 Using the Flash	
DC20 only L 1632x1224	2.1 frames	2.5 frames	1.8 frames	10 images
DC20 M 1280x960 DC10 L 1280x960	2.5 frames	4.2 frames	2.1 frames	10 images
S 640x480	2.5 frames	4.2 frames	2.1 frames	60 images

These figures are approximate and vary with the recording conditions and subjects. Sufficient space on the memory card is required. Continuous shooting stops when the card is full.

- The actual number of frames per second will be lower when “” (camcorder shake warning) is displayed on the screen.

Creating Panoramic Images

You can shoot a series of overlapping images and merge them on a computer into one large panoramic image using the supplied software (PhotoStitch).

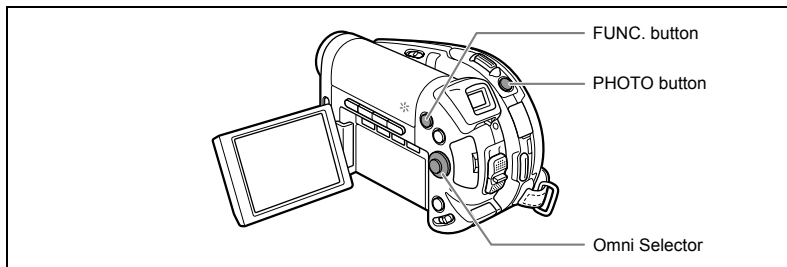

When Recording in Stitch Assist Mode:

PhotoStitch detects the overlapping portion of adjoining images and merges them. Try to include a distinctive item (landmark, etc.) in the overlapping portion.



1. Set the camcorder to record still images on the card (**CAMERA** · /) and move the mode switch to a position other than **AUTO**.

If you are recording stills on the disc (), change the media for the still images (34).

2. Press the **FUNC.** button.
3. First, select () the current drive mode symbol from the left side column and then select () the [STITCH AST] option from the bottom bar and press ().
 - The Stitch Assist screen appears.
 - The manual focus and manual exposure adjustment cannot be used with the Stitch Assist mode; these modes will be canceled when the Stitch Assist screen appears.
4. Select () the direction in which you will take the sequence of still images.
5. Select the recording program and zoom on the subject.

Once the sequence has started, you cannot change the recording program, exposure, zoom or focus.

6. Press the **PHOTO** button to record the first image.

The number of images recorded so far and the direction and number of the next image appear below the image.

7. Record the next image so that it overlaps a portion of the previous one. Repeat this step until you complete the panoramic image.

- Minor discrepancies in the overlapping area can be corrected with the software.
- You can retake an image using the omni selector (◀▶) to cancel the last recorded image and return to the previous one.
- Up to 26 images can be recorded.

8. Press the FUNC. button after the last image.

For details on how to merge these images, refer to the *Digital Video Software* instruction manual.











- Compose each image so that it overlaps 30 to 50% of the adjoining image. Try to keep the vertical misalignment within 10%.
- Do not include a moving subject in the overlapping portion.
- Do not try to stitch images that include both distant and close subjects. They may appear warped or doubled up.

Using the Digital Effects

The Digital Effects include faders, video effects, multi-image screen and card mix. All digital effects are available only when recording movies (**CAMERA** · **MOVIE**), except for the **BLK & WHT** (Black and White) effect, which is available also when recording still images (**CAMERA** · **STILL**).





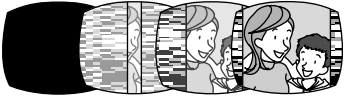



Faders (70)

Begin or end scenes with a fade to or from black.

<p>1 Fade Trigger (FADE-T)</p> 	<p>2 Wipe (WIPE)</p> 
<p>3 Corner Wipe (CORNER)</p> 	<p>4 Jump (JUMP)</p> 
<p>5 Flip (FLIP)</p> 	<p>6 Puzzle (PUZZLE)</p> 
<p>7 Zigzag (ZIGZAG)</p> 	<p>8 Beam (BEAM)</p> 
<p>9 Tide (TIDE)</p> 	

Effects (📖 70)

Add flavor to your recordings.

<p>1 Black and White (BLK & WHT)</p> 	<p>2 Sepia (SEPIA)</p> 	<p>3 Art (ART)</p> 
<p>4 Mosaic (MOSAIC)</p> 	<p>5 Ball (BALL)</p> 	<p>6 Cube (CUBE)</p> 
<p>7 Wave (WAVE)</p> 	<p>8 Color Mask (COLOR M.)</p> 	<p>9 Mirror (MIRROR)</p> 

Multi-Image Screen (📖 71)

Captures moving subjects as a sequence of 4, 9 or 16 still images and displays them as one split screen. Sound will be recorded normally.

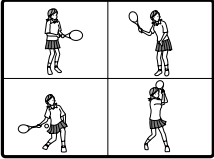
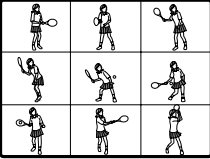
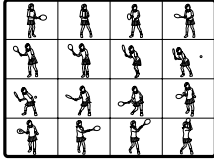
<p>4 split images</p> 	<p>9 split images</p> 	<p>16 split images</p> 
---	---	--

Card Mix (📖 72)

Combines a still image from the memory card with your recording.

Selecting a Fader

FUNC.
(57)



1. Set the camcorder to record movies (**CAMERA**) and move the mode switch to a position other than **AUTO**.
2. Press the **FUNC.** button.

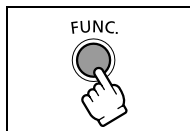

3. First, select (**▲▼**) the current digital effects symbol from the left side column and then select (**◀▶**) the [**FADER**] option from the bottom bar and press (**SET**).

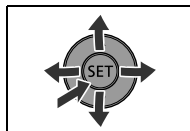

4. Select (**◀▶**) a fader from the list.

The selected fader will be demonstrated on the current screen and will also be shown in a small animation at the right corner of the bottom bar.

5. Press the **FUNC.** button to save the setting and close the menu.

The symbol of the selected fader appears.

6. Press the **D.EFFECTS** button.

- The symbol changes to green.
- Pressing the **D.EFFECTS** button again deactivates the fader.

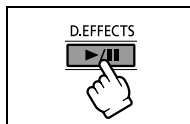

7. **Fade in:** Press the start/stop button in record pause mode.

Fade out: Press the start/stop button in record mode.

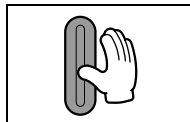

Selecting an Effect

FUNC.
(57)



1. Set the camcorder to a recording mode (**CAMERA** or **CAMERA**) and move the mode switch to a position other than **AUTO**.
2. Press the **FUNC.** button.

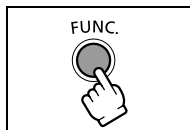

3. First, select (▲▼) the current digital effects symbol from the left side column and then select (◀▶) the [EFFECT] option from the bottom bar and press (SET).

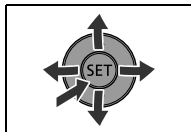

When recording still images on the memory card, only the [E] BLK&WHT] effect is available. Select it and skip step 4 below.

4. Select (◀▶) an effect from the list.

The selected effect will be demonstrated on the current screen and will also be shown in a small animation at the right corner of the bottom bar.

5. Press the FUNC. button to save the setting and close the menu.

The symbol of the selected effect appears.

6. Press the D.EFFECTS button.

- The symbol turns green, and the effect is activated.
- Pressing the D.EFFECTS button again deactivates the effect.



Using the Multi-Image Screen



1. Set the camcorder to record movies (CAMERA) and select a recording program other than AUTO or [M].
2. Press the FUNC. button.

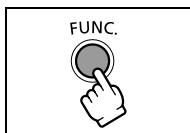

3. First, select (▲▼) the current digital effects symbol from the left side column and then select (◀▶) the [MULTI-S] option from the bottom bar and press (SET).

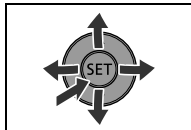

4. Select (▲▼) the [S.SPEED] option and set (◀▶) the transition speed.

- Manual: For capturing images manually.
- Fast: Every 4 frames
- Moderate (MOD.): Every 6 frames
- Slow: Every 8 frames

5. Select (▲▼) the [S.SPLIT] option and set (◀▶) the number of split images to capture.

6. Press (SET) to save the setting and press the FUNC. button to close the menu.

"[M]" appears.

7. Press the D.EFFECTS button.

- The symbol turns green.
- FAST, MODERATE, SLOW: The number of images selected will be captured at the set speed. To cancel the multi-image screen, press the D.EFFECTS button.
- MANUAL: Images will be captured every time you press the D.EFFECTS button. The blue frame indicating the next split image in the sequence disappears after the last image. Holding the D.EFFECTS button pressed down for more than 1 second cancels the images one after another.

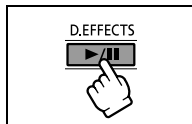

8. Press the start/stop button to begin recording.

The multi-image screen is recorded on the disc.

Combining Images (Card Mix)

You can choose one of the sample images (including picture frames, backgrounds and animations) from the collection on the supplied DIGITAL VIDEO SOLUTION DISK and combine it with your live video recording to add a note of playfulness to your movies.

Card Chroma Key (CARD CHROMA)

Combines frames with your recordings. The live video recording will appear instead of the blue area of the card mix image.

Mix level adjustment: blue area of the still image.



Card Luminance Key (CARD LUMI.)

Combines illustrations or titles with your recordings. The live video recording will appear instead of the light area of the card mix image.

Mix level adjustment: light area of the still image.



Camera Chroma Key (CAM. CHROMA)

Combines backgrounds with your recordings. Record your subject in front of a blue background and any part of your subject that is not blue will appear superimposed on the picture with the card mix image serving as background.

Mix level adjustment: blue area of the live video recording.



Card Animation (C. ANIMATION)

Combines animations with your recordings. You can choose from three types of card animation effects.

- Corner: The animation appears on the upper left and the lower right corner of the screen.
- Straight: The animation appears on the top and bottom of the screen and moves right and left.
- Random: The animation moves randomly on the screen.

Mix level adjustment: blue area of the card animation image.



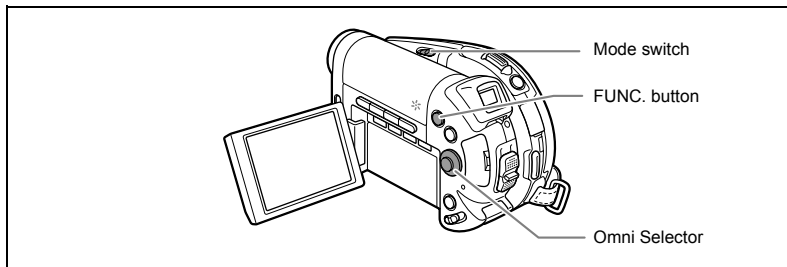

FUNC.
(57)



1. Set the camcorder to record movies (**CAMERA**).
2. Upload a sample image from the supplied disc to the memory card.
Refer to *Adding Still Images from Your Computer to the Memory Card* in the *Digital Video Software* instruction manual.
3. Move the mode switch to a position other than **AUTO**.
4. Press the **FUNC.** button.
5. First, select (▲▼) the current digital effects symbol from the left side column and then select (◀▶) the [CARD MIX] option from the bottom bar and press (SET).
6. Select (▲▼) the [IMAGE SELECT] option, and then select (◀▶) the still image you want to combine.
 - The still image will be displayed briefly.
 - Only still images recorded on the memory card can be selected for the Card Mix function, regardless of the current media selection for still images.
7. Select (▲▼) the [MIX TYPE] option, and set (◀▶) a mix type appropriate for the image you selected.
If you selected [C.ANIMATION], select (▲▼) [ANIMAT.TYPE] and set (◀▶) the animation type preferred.
8. If you want to adjust the mix level, select (▲▼) [MIX LEVEL] and set (◀▶) the level preferred.
9. Press (SET) to save the settings and press the **FUNC.** button to close the menu.
“ ” appears.
10. Press the **D.EFFECTS** button.
“ ” turns green and the combined image appears.



- Turn off the digital effects [D.EFFECT OFF] when you are not using them.
- The camcorder retains the setting last used even if you turn off the digital effects or change the recording program.
- The image quality may be slightly lower with digital effects.









Selecting the Size and Quality of Still Images

Still images are recorded on the memory card or the disc using the JPEG (Joint Photographic Experts Group) compression.









You can select the size and quality of still images. As a general rule select a larger image size for higher quality stills (for example for printing and enlarging); or a smaller image size if you want to record more images on the memory card or want smaller file sizes (for example for e-mail attachments or for web pages).

The actual number of still images that can be recorded on a memory card or disc will vary depending on the subject and the recording conditions. The estimated figures are as follows:

Number of still images that can be recorded on a memory card:

Image Size	Image Quality	Number of Images		
		16MB	128MB	256MB
DC20 only L 1632X1224	 Super Fine	9	85	175
	 Fine	14	135	275
	 Normal	25	250	500
DC20 M 1280X960 DC10 L 1280X960	 Super Fine	15	140	280
	 Fine	20	215	430
	 Normal	40	395	795
S 640X480	 Super Fine	75	690	1380
	 Fine	105	955	1900
	 Normal	170	1525	3040

Number of still images that can be recorded on a disc:

Image Size	Image Quality	Number of Images	
		VIDEO MODE (DVD-R/-RW)	VR MODE (DVD-RW)
DC20 only L 1632X1224	 Super Fine	1025	1045
	 Fine	1585	1615
	 Normal	2910	2960
DC20 M 1280X960 DC10 L 1280X960	 Super Fine	1630	1660
	 Fine	2495	2540
	 Normal	4595	4675
S 640X480	 Super Fine	7945	8085
	 Fine	9999	(11860)*
	 Normal	9999	(19765)*

* This number is the number of images that can be recorded on the disc; however, the maximum number of remaining images displayed on the screen will be 9999.



- Depending on the number of images on the memory card or disc (Windows: more than 1800 images; Macintosh: more than 1000 images), you may not be able to download images to a computer. Try using a card reader to download the still images recorded on the memory card.
- Connection to a PictBridge compliant printer will not work when the memory card contains more than 1800 images. For best performance, we recommend to keep the number of images on the memory card under 100.

FUNC

(57)

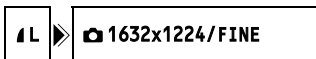

1. Set the camcorder to record still images (**CAMERA** ·).
2. Press the **FUNC.** button.
3. First, select (**▲▼**) the current image size and quality symbol from the left side column and then select (**◀▶**) the desired image size from the bottom bar.

The number on the right indicates the approximate number of images that can be recorded on the memory card or disc at the current image size/quality setting.

4. If you want to change also the image quality: Press (**SET**) and select (**◀▶**) the desired image quality from the bottom bar.
 - The number on the right indicates the approximate number of images that can be recorded on the memory card or disc at the current image size/quality setting.
 - You can press (**SET**) again to go back to select the image size (step 3).
5. Press the **FUNC.** button to save the setting and close the menu.

Capturing a Still Image while Recording Movies



While you are recording a movie on the disc you can simultaneously capture the same picture as a still image on the memory card without interrupting your recording to change modes. The size of the still image will be 640x480 and cannot be changed, but the image quality can be selected.

FUNC.

( 57)





 STILL I. REC OFF

1. Set the camcorder to record movies ().
2. Press the FUNC. button.
3. First, select () the current image recording symbol from the left side column and then select () the desired image quality from the bottom bar.
4. Press the FUNC. button to save the setting and close the menu.
5. While you are recording a movie, press the PHOTO button.

The still image is recorded on the memory card while the screen continues to show the video recording.



- The quality of the still image is slightly lower than a still image of the same size recorded in the  mode.
- The still image cannot be recorded on the memory card while recording in widescreen or while a digital effect is activated.
- The still image cannot be recorded simultaneously on the disc. Make sure that the memory card is selected as the media for still images ( 34).

Changing Settings with the MENU Button

You can modify many aspects of how your camcorder operates from the various setup menus that open after pressing the MENU button. For a list of the settings that can be changed using these setup menus, see *Available Settings List (MENU)* (□ 78).

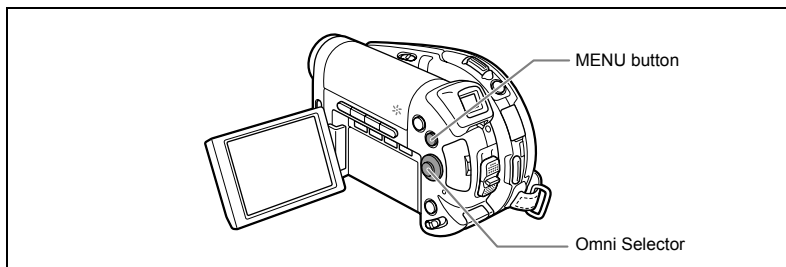

Selecting Menus and Settings

1. Press the MENU button.

The menu opens.

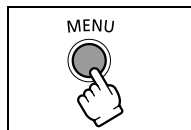

2. Use the omni selector (▲▼) to select the setup menu from the left side column and press (SET).

3. Select (▲▼) the setting you want to change and press (SET) to make the selection.

4. Select (▲▼) the desired option and press (SET) to save the setting.

5. Press the MENU button.

The menu closes.

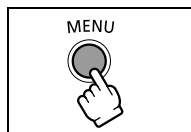
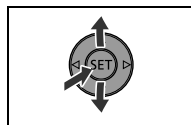







- Pressing the MENU button at any time closes the menu.
- Menu items not available appear grayed out.

Available Settings List (MENU)



Available menu items vary depending on the operation mode. Default settings are in boldface text. For details on each function, see the reference page. Functions without a reference page are explained below the tables.

CAMERA SETUP

Menu Items	Setting Options	CAMERA		PLAY		
						
A.SL SHUTTER	ON ON, OFF OFF	<input type="radio"/>	<input type="radio"/>			-
D.ZOOM	OFF OFF, 40x 40X, 200x 200X	<input type="radio"/>				-
IMG STAB	ON ON, OFF OFF	<input type="radio"/>				-
DC20 only AF AST LAMP	A AUTO, OFF OFF	<input type="radio"/>	<input type="radio"/>			55
FOCUS PRI.	ON ON, OFF OFF		<input type="radio"/>			-
REVIEW	OFF OFF, 2s 2sec, 4s 4sec, 6s 6sec, 8s 8sec, 10s 10sec		<input type="radio"/>			-
WIND SCREEN	ON ON  , OFF OFF	<input type="radio"/>	<input type="radio"/>	<input type="radio"/>		-
SELF TIMER	ON ON, OFF OFF	<input type="radio"/>	<input type="radio"/>			56

¹ Available only when recording still images on the memory card .

A.SL SHUTTER: The camcorder automatically uses slow shutter speeds to obtain brighter recordings in places with insufficient lighting.

- The camcorder uses shutter speeds down to 1/25 (1/12 when recording still images).
- When recording still images, set the flash mode to  (flash off).
- If a trailing afterimage appears, set the slow shutter to [OFF].
- If “” (camcorder shake warning) appears, we recommend stabilizing the camcorder, for example, by mounting it on a tripod.

D.ZOOM: Determines the operation of the digital zoom.

- When the digital zoom is activated, the camcorder will switch automatically to the digital zoom when you zoom in beyond the optical zoom range.
- With the digital zoom the image is digitally processed, so image resolution will deteriorate the more you zoom in.
- The digital zoom indicator will appear in light blue from 10x up to 40x and dark blue from 40x to 200x.
- The digital zoom cannot be used in the following cases:
 - In the Night recording program (SCN)
 - With the Multi-Images Screen

IMG STAB (👉): The image stabilizer compensates for camcorder shake even at full telephoto.

- The image stabilizer is designed to compensate for a normal degree of camcorder shake.
- The image stabilizer may not be effective when recording in dark places using the Night recording program (SCN).
- The image stabilizer cannot be turned off when the mode switch is in the **AUTO** position.
- We recommend turning off the image stabilizer when using a tripod.

FOCUS PRI.: The camcorder records the still image only after the focus has been adjusted.

- Set it to [OFF] if you wish to record a still image as soon as you press the PHOTO button.
- When set to [OFF], no focusing frame appears.
- Focus priority cannot be turned off when the mode switch is in the **AUTO** position.
- In the Fireworks recording program (SCN) the setting is automatically turned off.















REVIEW: Selects the time to display a still image after it has been recorded on the memory card.

- You can erase (🗑 92) or protect (🔒 94) the image if you press the FUNC. button while you are reviewing the image.
- This menu item will not be available (will appear grayed out) when 📷 (continuous shooting), 📷 (high-speed continuous shooting) or 📷 (auto exposure bracketing) is selected.

WIND SCREEN: When activated the camcorder will reduce the background sound of wind when recording outdoors.

- Set the camcorder to record movies (**CAMERA**) and move the mode switch to a position other than **AUTO**.
- Some low-frequency sounds will be suppressed along with the sound of wind. We recommend to leave the wind screen off (the default setting) for most recording environments.

STILL IMAGE OPERATIONS

Menu Items	Setting Options	CAMERA		PLAY		
						
 ORD. ALL ERASE	NO, YES				○ ¹	121
 ORD. ALL ERASE	NO, YES				○ ¹	112
ERASE ALL IMAGES	NO, YES				○ ³	93
CARD INITIALIZE	NO, YES				○ ¹	95
ALL COPY [ → ]	NO, YES				○ ¹	90
ALL COPY [ → ]	NO, YES				○ ²	90
→  PROTECT					○ ⁴	94
→  PRINT ORDER					○ ⁴	120
→  TRANSFER ORDER					○ ⁴	111





¹ This option is available only when viewing a single still image on the memory card .



² This option is available only when viewing a single still image on the disc .

³ This option is available when viewing a single still image on the disc or card.

⁴ This option is available only when viewing still images on the memory card  in the index screen.

DISC OPERATIONS

Menu Items	Setting Options	CAMERA		PLAY		
						
DISC INITIALIZE	VIDEO, VR	○	○ ¹	○	○ ¹	89
FINALIZE	NO, YES	○	○ ¹	○	○ ¹	96
UNFINALIZE	NO, YES	○	○ ¹	○	○ ¹	99
PLAYLST ALL DEL	NO, YES			○ ²		85
MOVIES ALL DEL	NO, YES			○ ³		85
DISC PROTECT	NO, YES			○	○ ¹	88
PHOTOMOVIE	NO, YES				○ ¹	87
DISC TITLE				○		96

¹ This option is available only when recording still images on the disc , or when viewing still images recorded on the disc .

² This option is available only in the playlist mode.

³ This option is available only in the original movies mode.

DISPLAY SETUP

Menu Items	Setting Options	CAMERA		PLAY		
BRIGHTNESS		<input type="radio"/>	<input type="radio"/>	<input type="radio"/>	<input type="radio"/>	-
LCD MIRROR	ON ON , OFF OFF	<input type="radio"/>	<input type="radio"/>	<input type="radio"/>	<input type="radio"/>	-
DATA CODE	DATE, TIME, DATE & TIME , CAMERA DATA, CAM. & D/T	<input type="radio"/>	<input type="radio"/>	<input type="radio"/>	<input type="radio"/>	43
	DATE, TIME, DATE & TIME	<input type="radio"/>	<input type="radio"/>	<input type="radio"/>	<input type="radio"/>	
LANGUAGE	DEUTSCH, ENGLISH , ESPAÑOL, FRANÇAIS, ITALIANO, РУССКИЙ, 简体中文, 繁體中文, 한국어, 日本語	<input type="radio"/>	<input type="radio"/>	<input type="radio"/>	<input type="radio"/>	25
DEMO MODE	ON ON , OFF OFF	<input type="radio"/>	<input type="radio"/>	<input type="radio"/>	<input type="radio"/>	-

BRIGHTNESS: Adjusts the brightness of the LCD screen.

- Use the omni selector (◀▶) to adjust the brightness to your preference.
- Changing the brightness of the LCD screen does not affect that of the viewfinder or the recordings.

LCD MIRROR: When you rotate the LCD panel 180 degrees to face the subject, the picture displayed will be a mirror image (right and left reversed) so that the image on the display will match that of the subject. All on-screen displays will also be reversed.

DEMO MODE: The demonstration mode displays the camcorder's main features. It starts automatically when the camcorder is powered with the power adapter if you leave it turned on without loading a recording media for more than 5 minutes.

- To cancel the demo mode once it started, press any button, turn off the camcorder or load a recording media.

SYSTEM SETUP

Menu Items	Setting Options	CAMERA		PLAY		
MEDIA SEL.	CARD , DISC	<input type="radio"/>	<input type="radio"/>	<input type="radio"/>	<input type="radio"/>	34
WL. REMOTE	ON ON , OFF OFF	<input type="radio"/>	<input type="radio"/>	<input type="radio"/>	<input type="radio"/>	-
VOLUME		<input type="radio"/>	<input type="radio"/>	<input type="radio"/>	<input type="radio"/>	41
BEEP	HIGH VOLUME , LOW VOLUME, OFF OFF	<input type="radio"/>	<input type="radio"/>	<input type="radio"/>	<input type="radio"/>	-
POWER SAVE	ON ON , OFF OFF	<input type="radio"/>	<input type="radio"/>	<input type="radio"/>	<input type="radio"/>	-
FILE NOS.	RESET , CONTINUOUS	<input type="radio"/>	<input type="radio"/>	<input type="radio"/>	<input type="radio"/>	-

WL. REMOTE: Allows the camcorder to be operated with the wireless controller.

BEEP: A beep will accompany some operations like turning on the camcorder, the self-timer countdown, etc. It also serves as a warning beep under unusual conditions.

POWER SAVE: In order to save power when the camcorder is powered by a battery pack, it will automatically shut off if left without any operation for five minutes. Approximately 30 seconds before the camcorder shuts off, “ AUTO POWER OFF” appears in the center of the screen.

FILE NOS.: Select the image numbering method to be used on a new memory card or disc.





Images are automatically assigned consecutive image numbers from 0101 to 9900, and stored in folders containing up to 100 images. Folders are numbered from 101 to 998.

[RESET]: Image numbering will start anew from 101-0101 every time you insert a new memory card or disc. If it already contains image files, a new image will be given the number following that of the last image on the memory card or disc.

[CONTINUOUS]: Image numbering will start from the number following that of the last image recorded with the camcorder. If the memory card or disc already contains an image with a larger image number, a new image will be given the number following that of the last image on the recording media.

- The [CONTINUOUS] image numbering method is useful for organizing images on a computer as it minimizes the chance of two images being assigned the same image number. We recommend using this setting.
- The [FILE NOS.] setting is common to the memory card and the disc.

D/TIME SET

Menu Items	Setting Options	CAMERA		PLAY		
						
T.ZONE/DST		<input type="radio"/>	<input type="radio"/>	<input type="radio"/>	<input type="radio"/>	
DATE/TIME		<input type="radio"/>	<input type="radio"/>	<input type="radio"/>	<input type="radio"/>	
DATE FORMAT	Y.M.D (2005.1.1 AM12:00), M.D.Y (JAN. 1, 2005 AM12:00), D.M.Y (1.JAN.2005 AM12:00)	<input type="radio"/>	<input type="radio"/>	<input type="radio"/>	<input type="radio"/>	26

DATE FORMAT: Changes the displayed date format (including the date format for printing).

Creating a Playlist

Create a playlist to easily edit your movies (for example, change the order in which the scenes you recorded will be played back or edit scenes including only the best parts and cutting out the rest) without affecting your original recordings. After you create a playlist you will have two index screens: that of your original recordings (the scene index screen) and the one you edit as a playlist (the playlist index screen).

Available only with DVD-RW discs recorded in VR mode.

Adding Scenes to the Playlist

1. Set the camcorder to play movies (**PLAY**).
2. From the index screen, select (**▲▼**, **◀▶**) the scene you want to add to the playlist and press the **FUNC.** button.
To add all the movies to the playlist there is no need to select any particular scene.
3. Select (**▲▼**) the  (**ADD TO PLAYLIST**) icon and press (**SET**).

To add all scenes to the playlist:

4. Select (**▲▼**) **[ALL SCENES]** and press (**SET**).
 - Select [CANCEL] to go back to the index screen.
 - When the operation is completed "ADDED TO PLAYLIST" will be displayed.

To add only the selected scene to the playlist:

4. Select (**▲▼**) **[ONE SCENE]** and press (**SET**).
Select [CANCEL] to go back to the index screen.
5. Select (**◀▶**) **[YES]** and press (**SET**).
When the operation is completed "ADDED TO PLAYLIST" will be displayed.

Moving Scenes in the Playlist











1. Set the camcorder to play movies (**PLAY**).
2. Press the **PLAYLIST** button to open the playlist index screen.
3. Select (**▲▼**, **◀▶**) the scene you want to move.
The scene to be moved will be marked by the orange selection frame.
4. Press the **FUNC.** button.
5. Select the  (**MOVE**) icon and press (**SET**).
6. Move (**▲▼**, **◀▶**) the red marker to indicate where you want to move the scene and press (**SET**).
7. Select **[YES]** and press (**SET**) to move the scene to the selected destination.



Dividing a Scene

You can divide your recordings in order to leave only the best parts and later cut out the rest. Remember that when you divide scenes in the playlist, you do not affect your original recordings allowing you to easily try out different “director cuts”.

Available only with DVD-RW discs recorded in VR mode.

Dividing Scenes

1. Set the camcorder to play movies ().
2. From the index screen, select (, ) the scene you want to divide and press the FUNC. button.
3. Select () the  (DIVIDE) icon and press ().
 - The scene will be played back.
 - You can also press the FUNC. button while playing back a scene.
4. At the place where you want to divide the scene, press the  button to pause the playback.
5. If necessary, in order to bring the scene to a precise point select () the  icon and press () to respectively, reverse or advance one frame at a time.

If you want to select a different scene, select the  icon and press () to skip to the next or previous scene. Press the  button to resume normal playback and return to step 4 above.

6. Select () the  icon and press ().

7. Select [YES] and press () to divide the scene.

The second part of the scene (starting from the dividing point) will be added as a separate scene immediately after the original one.

To Divide a Scene only in the Playlist

After Step 1 above, press the PLAYLIST button to open the playlist index screen and continue the procedure as described.



- Photomovie scenes and scenes created by converting single still images cannot be divided.
- Scenes shorter than 5 seconds cannot be divided.

Deleting Scenes

You can delete those scenes that you are not interested in keeping. Remember that when you delete scenes in the playlist, you do not affect your original recordings allowing you to easily try out different “director cuts”.

This option is only available with DVD-RW discs (VIDEO or VR mode). However, with DVD-RW discs recorded in VIDEO mode only the last scene can be deleted and only while reviewing it immediately after recording the scene (□ 32).











Be careful when deleting original recordings. Once deleted, an original scene cannot be recovered.



- When a disc is protected (□ 88), original recordings cannot be deleted.
- You may not be able to delete scenes shorter than 5 seconds long.

Deleting a Single Scene

This option is only available with DVD-RW discs recorded in VR mode.

1. **Set the camcorder to play movies ().**
2. **From the index screen, select (, ) the scene you want to delete and press the FUNC. button.**
You can also press the FUNC. button while playing back a scene. After pressing the FUNC. button, press the  button to pause the playback.
3. **Select () the  (DELETE) icon and press ().**
4. **Select [YES] and press () to delete the scene.**







Deleting an original recording, will also delete the scene from the playlist.

To Delete a Scene only from the Playlist

After Step 1 above, press the PLAYLIST button to open the playlist index screen and continue the procedure as described.

Deleting a Scene After Recording

As long as you haven't turned the camcorder off or changed the operation mode after recording a scene, you can delete it while reviewing it. This option is only available with DVD-RW discs (VIDEO or VR mode).

1. **Immediately after recording a scene, press the  (record review) button.**
2. **While reviewing the scene, use the omni selector (, ) to select the  icon and press ().**
3. **Select () [YES] and press () to delete the scene.**







Deleting All Scenes

This option is only available with DVD-RW discs recorded in VR mode.

MENU

( 77)



1. Set the camcorder to play movies ().
2. Press the MENU button.
3. Use the omni selector (, , ) to select the [DISC OPERATIONS] menu and then select the [MOVIES ALL DEL] option.
4. Select [YES] and press () to delete all the scenes.
 - Select [NO] and press () to cancel the operation and return to the menu.
 - Deleting all the original scenes will also delete the whole playlist.
5. Press the MENU button to close the menu.

To Delete the Whole Playlist

After Step 1 above, press the PLAYLIST button to open the playlist index screen and in Step 3 select the [PLAYLST ALL DEL] option. Continue the procedure as described.

Converting Still Images into Photomovie Scenes

Still images are recorded using JPEG compression, but a DVD player only recognizes the MPEG standard. That is why in order to display your still images as one more scene in your DVD, first you have to create a Photomovie scene that will be added as one more scene along with your movies.

A Photomovie is a slide show of all still images on the disc, where each image will be displayed for approx. 3 seconds. If you want to add still images recorded on the memory card to your Photomovie scene, copy them to the disc in advance (□ 90).

This option is only available with DVD-RW discs (VIDEO or VR mode).

Converting a Single Image



1. Set the camcorder to view still images recorded on the disc (**PLAY** / **DISC**).
2. Select (**◀▶**) the still image you want to convert to a scene and press the **FUNC.** button.
3. First, select (**▲▼**) the [**CONVERT TO SCENE**] symbol and press (**SET**).
4. Select (**◀▶**) the [**EXECUTE**] option and press (**SET**) to convert the still image.
5. Press the **FUNC.** button to close the menu.

Converting All Images

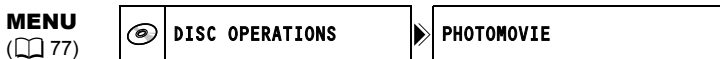

1. Set the camcorder to view still images recorded on the disc (**PLAY** / **DISC**).
2. Press the **MENU** button.
3. Use the omni selector (**▲▼** , **SET**) to select the [**DISC OPERATIONS**] menu and then select the [**PHOTOMOVIE**] option.
4. Select [**YES**] and press (**SET**) to create the Photomovie.
 - Select [**NO**] and press (**SET**) to cancel the operation and return to the menu.
 - Depending on the number of still images, this operation may take some time.
5. Press the **MENU** button to close the menu.



- Even after being converted to Photomovie scenes, the original still images will remain recorded on the disc without change.
- If during the creation of a Photomovie scene the disc becomes full, the operation will be canceled.

Protecting the Disc

You can protect the whole disc in order to prevent the accidental erasure of important recordings.

Available only with DVD-RW discs recorded in VR mode.



Initializing the disc (89) will permanently erase all recordings, even if the disc is protected.

MENU
(77)



1. Set the camcorder to play movies or view still images recorded on the disc (**PLAY** · or **PLAY** · /).
2. Press the MENU button.
3. Use the omni selector (, , **SET**) to select the [DISC OPERATIONS] menu and then select the [DISC PROTECT] option.
4. Select [YES] and press (**SET**) to protect the disc.
Select [NO] and press (**SET**) to cancel the operation and return to the menu.
5. Press the MENU button to close the menu.

Initializing the Disc

You need to initialize a DVD-RW disc when first inserting it into the camcorder and you may have to initialize a disc if you get the "DISC ERROR" message. You can also choose to initialize the disc if you wish to erase all the recordings on the disc or in order to change the disc specification.

When initializing a disc, all the recorded data will be lost.



- Initializing the disc will permanently erase all recordings, even if the disc is protected.
- Once the disc is initialized, the original recordings cannot be recovered.
- Except for the included disc, initialize all discs before using them with this camcorder.

MENU
(77)



1. Set the camcorder either to record or play movies or to record or view still images on the disc (**CAMERA** · , **PLAY** · , **CAMERA** · / or **PLAY** · /).
2. Press the **MENU** button.
3. Use the omni selector (**▲▼**,) to select the **[DISC OPERATIONS]** menu and then select the **[DISC INITIALIZE]** option.
4. Select (**▲▼**) the disc specification and press ().
 - [VIDEO] mode: Most DVD players will play the disc, but except for the disc title, the recordings cannot be edited with the camcorder.
 - [VR] mode: You will have the option to edit the recordings with the camcorder, but the disc can only be played in VR-compatible DVD players and computer DVD drives.
5. You will be asked to confirm the disc specification you selected. Use the omni selector (**▲▼**) to select **[YES]** and press () to continue. Select **[NO]** and press () to return and select a different disc specification.
6. Select **[YES]** and press () to initialize the disc.
 - Select **[NO]** and press () to cancel the operation and press **MENU** to close the menu.
 - The disc initialization will take approximately one minute. Avoid moving the camcorder while the operation is in progress.

Copying Still Images Between the Disc and Memory Card

You can copy still images recorded on the memory card to the disc (for example, to add them to a Photomovie scene (□ 87)), or from the disc to the memory card (for example, to set print orders for a DPOF compatible printer (□ 120)).

Copying a Single Image

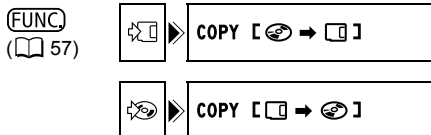

1. Set the camcorder to view still images (**PLAY** + **Camera**).

Select as the media for the still images, the media from where you want to copy images.

2. Press the FUNC. button.

3. First, select (**▲▼**) the [COPY [**Disc** → **Card**]] symbol and press (**SET**).

If you are copying still images from the memory card to the disc, [COPY [**Card** → **Disc**]] will appear instead.

4. Select (**◀▶**) the [EXECUTE] option and press (**SET**) to copy the still image.

5. Press the FUNC. button to close the menu.

Copying All Images



1. Set the camcorder to view still images (**PLAY** + **Camera**).

Select as the media for the still images, the media from where you want to copy images.

2. Press the MENU button.

3. Use the omni selector (**▲▼**, **◀▶**) to select the [STILL IMG OPER.] menu and then select the [ALL COPY [**Disc** → **Card**]] option.

- If you are copying still images from the memory card to the disc, [ALL COPY [**Card** → **Disc**]] will appear instead.
- The total size of all image files and the available space on the destination media will be displayed.

4. Select [YES] and press () to copy the still images.

5. Press the MENU button to close the menu.



- Still images not recorded with this camcorder may not be copied correctly.
- When the available space on the copy destination is not enough, the copy operation will be canceled without copying all images.
- The copy operation may take a while to complete depending on the number and total size of the image files.

Erasing Still Images

You can erase still images recorded on the memory card or on the disc (DVD-RW only), one at a time or all at once.



Be careful when erasing images. Erased images cannot be recovered.



Protected images on the memory card and images on a protected disc cannot be erased.

Erasing a Single Image

Still images recorded on the disc: This option is only available with DVD-RW discs recorded in VR mode.



1. Set the camcorder to view still images (**PLAY**).
2. Press the **FUNC.** button.
3. First, select (**▲▼**) the [**IMAGE ERASE**] symbol and press (**SET**).
4. Select (**◀▶**) the [**ERASE**] option and press (**SET**) to erase the still image.
5. Press the **FUNC.** button to close the menu.

Erasing a Single Image After Recording

You can erase the still image you recorded last while you are reviewing it immediately after recording it. Still images on the disc: This option is only available with DVD-RW discs (VIDEO or VR mode).



1. While reviewing the image immediately after recording it press the **FUNC.** button.
2. First, select (**▲▼**) the [**IMAGE ERASE**] symbol and press (**SET**).
3. Select (**◀▶**) the [**ERASE**] option and press (**SET**) to erase the still image.
4. Press the **FUNC.** button to close the menu.

Erasing All Images

Still images recorded on the disc: This option is only available with DVD-RW discs recorded in VR mode.

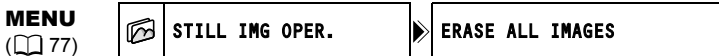

1. Set the camcorder to view still images (**PLAY**).
2. Press the MENU button.
3. Use the omni selector (**▲▼**, **SET**) to select the [STILL IMG OPER.] menu and then select the [ERASE ALL IMAGES] option.
4. Select [YES] and press (**SET**) to erase the still images.
All the non protected still images on the media currently selected, will be erased.
5. Press the MENU button to close the menu.









Protecting Still Images on the Memory Card

You can protect still images recorded on the memory card from accidental erasure while displaying a single image or from the index screen.

 Initializing the memory card (□ 95) will permanently erase all recorded still images, even the protected ones.









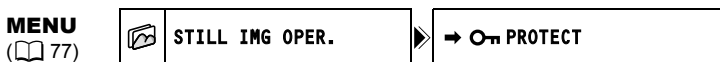

Protecting a Single Image



1. Set the camcorder to view still images recorded on the memory card ( / ).
2. Press the FUNC. button.
The option is also available while recording still images () but only if you press the FUNC. button while reviewing the still image (□ 79) immediately after recording.
3. First, select () the [ PROTECT] symbol and press ().
4. Select () the [ON] option and press () to protect the still image.
5. Press the FUNC. button to close the menu.
 - “  ” appears, and now the image cannot be erased.
 - To cancel the protection, select [OFF] in step 4.

Protecting Still Images from the Index Screen



1. Set the camcorder to view still images recorded on the memory card ( / ).
2. Move the zoom lever toward **W**.
The stills index screen appears with up to six still images.
3. Press the MENU button and use the omni selector ( , ) to select the [STILL IMG OPER.] menu and then select the [ PROTECT] option.
4. Bring ( , ) the cursor () to the image you want to protect and press ().
 - “  ” appears on the image.
 - To cancel the protection, press () again.
5. Press the MENU button to close the menu.

Initializing the Memory Card

Initialize a new memory card when first inserting it into the camcorder. You may have to initialize a card if you get the "CARD ERROR" message or you may choose to do so to erase all data recorded on it.



- Initializing the card will permanently erase all the recorded still images, even the protected ones.
- Once the card is initialized, the original images cannot be recovered.
- Initialize all memory cards before using them with this camcorder.

MENU
(MENU 77)



1. Set the camcorder to view still images recorded on the memory card (PLAY / STILL).
2. Press the MENU button.
3. Use the omni selector (▲▼, SET) to select the [STILL IMG OPER.] menu and then select the [CARD INITIALIZE] option.
4. Select [YES] and press (SET).
A confirmation screen will appear.
5. Select [YES] again and press (SET).
The card initialization will take a moment.
6. Press the MENU button to close the menu.

Preparing your Disc for Playing on a DVD Player

In order to play the disc you recorded on a DVD player, a computer's DVD drive or other digital device, you need to finalize it first. Refer also to the instruction manual of the DVD player/recorder or the computer's DVD drive.



- When finalizing a disc, always power the camcorder directly from a power outlet. The finalization process cannot be started if the camcorder is powered only with the battery pack.
- Do not disconnect the power adapter while the disc finalization is in progress. Doing so can interrupt the process and result in lost data.
- Depending on the type of disc and the disc specification, after finalizing the disc you may not be able to initialize the disc, edit your recordings or add new recordings to the disc.
- Do not finalize with the camcorder discs that were not recorded using this camcorder.



- A finalized DVD-RW in VIDEO mode can be unfinalized to allow recording additional scenes and other limited editing options (p. 99).
- Once finalized, you cannot add recordings to a DVD-R disc.
- The time required to complete the disc finalization will vary depending on the scene recording conditions and the amount of free space remaining on the disc.

Restrictions after Disc Finalization

	Additional Recordings	Edit Recordings	Initializing the Disc
DVD-R in VIDEO mode	×	×	×
DVD-RW in VIDEO mode	×	×	○
DVD-RW in VR mode	○	○	○

Changing the Disc Title

Before you finalize your disc, you can give it a title. The disc title will not be displayed on the camcorder but will be displayed on the index screen when playing the finalized disc in most DVD players or a computer's DVD drive (depending on the DVD playing software).

MENU

(p. 77)



1. Set the camcorder to play movies or view still images recorded on the disc (**PLAY** or **PLAY** /).
2. Press the MENU button.
3. Use the omni selector (, ,) to select the [DISC OPERATIONS] menu and then select the [DISC TITLE] option.

4. Select (▲▼, ◀▶) one character at a time and press (SET) to add it to the title.
 - Select [BACKSPACE] and press (SET) to delete the last character in the title.
 - You can set a title up to 20 characters long.
5. Once you finish editing the title, select [SET] and press (SET).
6. Select [YES] and press (SET) to save the title.
 - Select [NO] and press (SET) to cancel the operation and return to the menu.
7. Press the MENU button to close the menu.

Finalizing the Disc

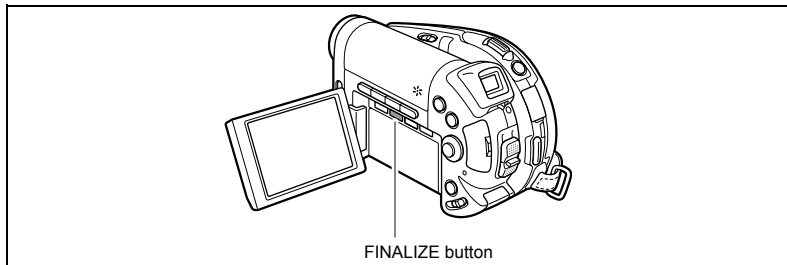

1. Set the camcorder either to record or play movies or to record or view still images on the disc (CAMERA • [CAMERA] , PLAY • [PLAY] , CAMERA • [CAMERA] / [CAMERA] or PLAY • [PLAY] / [PLAY]).
2. Press the FINALIZE button.
3. Select [YES] and press (SET) to start the disc finalization.
 - Select [NO] and press (SET) to cancel the operation.
 - The disc finalization progress bar and the remaining time are displayed.
 - Depending on the size of the non-recorded area of the disc, the finalization process may be lengthy.
 - Avoid moving the camcorder while the disc finalization is in progress.
 - When using a finalized disc, the finalization mark “F” will appear next to the disc type and disc specification displays.



The disc finalization can also be selected from the [DISC OPERATIONS] menu using the MENU button (p. 80).

Playing Back your Disc on a DVD Player or a Computer's DVD Drive

After you finalized your disc, you can play it on a DVD-R or DVD-RW compatible DVD player, DVD recorder or DVD drive on a computer. On most DVD players look for the DVD-R/RW compatibility logo . Refer also to the instruction manual of your DVD player or DVD recorder.

Playing the Disc on a DVD Player

1. Turn on the TV and DVD player.
2. Insert a finalized disc in the DVD player.
3. Select the scene you want to play from the index screen.

Playing the Disc on a Computer's DVD Drive

1. Insert a finalized disc in the computer's DVD drive.

To play back movies:

2. **If your DVD playback software does not launch automatically when inserting a DVD, run the DVD playback software.**

Refer also to the instruction manual and help modules of your DVD playback software.

To view still images recorded on the disc:

2. **If your DVD playback software is running, close it.**
3. **Select the DVD drive with the File Manager software installed in your computer (for example "My Computer" in Windows operating systems, etc.) and select the still images you want to display.**

You can alternatively use your preferred Image Management software or any other software for cataloguing, browsing or editing digital images installed in your computer.



You need to have DVD playback software installed in your computer to play the DVD.



- DVD-RW discs recorded in VR mode can only be played on VR compatible DVD players. Depending on your DVD player/recorder you may not be able to play the disc.
- In order to view the still images recorded on the disc in a DVD player, you have to convert individual images to scenes, or create a Photomovie scene - a slideshow scene of all the still images on the disc (□ 87) before you finalize the disc.
- The resolution of Photomovie scenes will be lower than that of the original still images.

Recording Additional Movies on a Finalized Disc

Recording additional scenes on a disc already finalized can be done only with DVD-RW discs. A finalized DVD-RW in VIDEO mode can be unfinalized to allow recording additional scenes and other limited editing options. With a DVD-RW recorded in VR mode you can record additional scenes without the need to unfinalize it. DVD-R discs cannot be unfinalized.

This option is only available with DVD-RW discs in VIDEO mode.



- When unfinalizing a disc, always power the camcorder directly from a power outlet. The unfinalization process cannot be started if the camcorder is powered only with the battery pack.
- Do not disconnect the power adapter while the disc unfinalization is in progress. Doing so can interrupt the process and result in a disc that cannot be recognized.
- Only discs that were finalized using this camcorder can be unfinalized with this camcorder.

MENU
(77)



1. Set the camcorder either to record or play movies or to record or view still images on the disc (**CAMERA** · , **PLAY** · , **CAMERA** · / or **PLAY** · /).
2. Press the **MENU** button.
3. Use the omni selector (, ,) to select the **[DISC OPERATIONS]** menu and then select the **[UNFINALIZE]** option.
4. Select **[YES]** and press () to start the disc unfinalization.
 - Select **[NO]** and press () to cancel the operation and return to the menu.
 - Avoid moving the camcorder while the disc unfinalization is in progress.
5. Press the **MENU** button to close the menu.

Playing Back on a TV Screen

TVs without SCART terminal

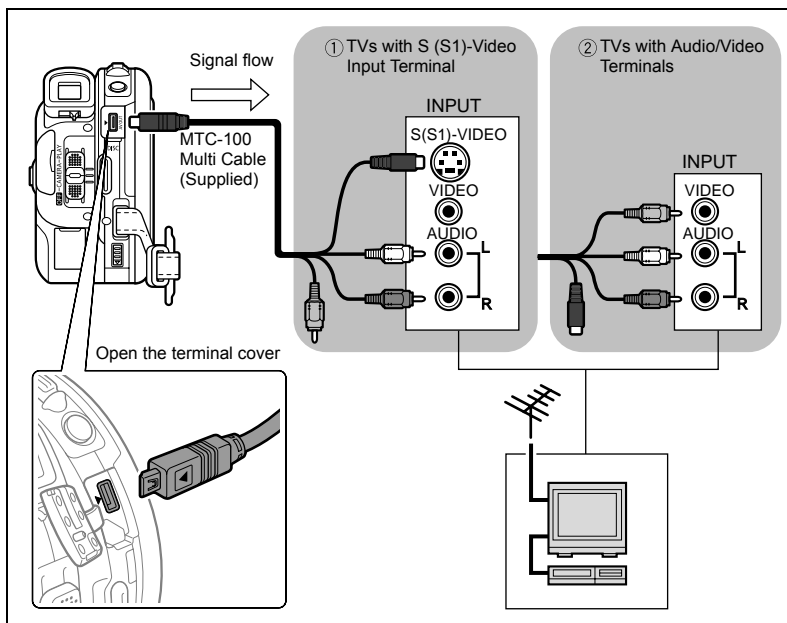

1. Turn off all devices before starting the connections.
2. Connect the MTC-100 Multi Cable to the camcorder's AV terminal and the audio terminals on the TV or VCR.
Connect the white plug to the white audio terminal L (left) and the red plug to the red audio terminal R (right).
3. Connect the MTC-100 Multi Cable to the video terminal on the TV or VCR.
If your TV or VCR has an S-VIDEO or (S1)-VIDEO input, connect the black plug to the S(S1)-VIDEO terminal and do not connect the yellow plug. Otherwise, connect the yellow plug to the yellow video terminal (VIDEO).
4. If connecting to a TV, set the input selector to VIDEO. If connecting to a VCR, set the input selector to LINE.



- We recommend powering the camcorder from a household outlet.
- Picture quality is better when connecting to a TV with an S (S1) terminal.

TVs with SCART terminal

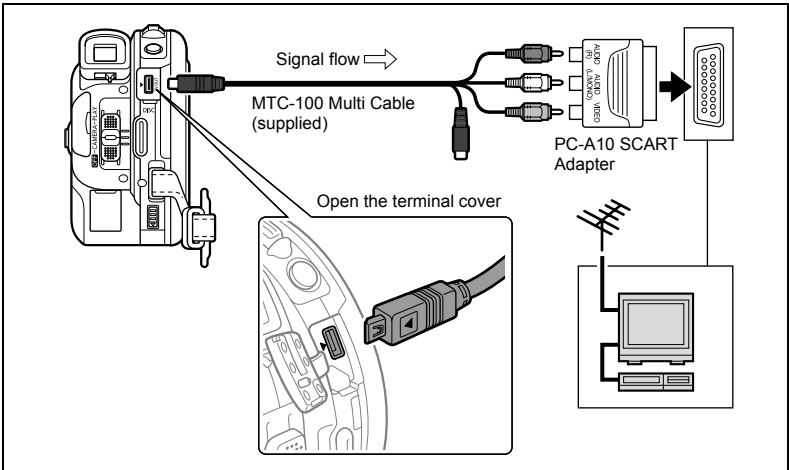

1. Turn off all devices before starting the connections.
2. Connect the PC-A10 SCART Adapter to the TV or VCR's terminals.
3. Connect the MTC-100 Multi Cable to the camcorder's AV terminal and the terminals on the SCART Adapter.
Connect the white plug to the white audio terminal L (left), the red plug to the red audio terminal R (right) and the yellow plug to the yellow video terminal.
4. If connecting to a TV, set the input selector to VIDEO. If connecting to a VCR, set the input selector to LINE.



- We recommend powering the camcorder from a household outlet.
- The supplied PC-A10 SCART Adapter is for output only.

Recording to a VCR

You can copy your recordings by connecting the camcorder to a VCR or a digital video device. For a connection diagram showing how to connect the camcorder to a VCR see the previous section *Playing Back on a TV Screen* (□ 100).

- 1. Set the camcorder to play movies () and load a recorded disc.**
- 2. Connected device: Load a blank cassette and set the device to record pause mode.**
- 3. This camcorder: Locate the scene you wish to copy and pause playback shortly before the scene.**
- 4. This camcorder: Resume the movie playback.**
- 5. Connected device: Begin recording when the scene you wish to copy appears. Stop recording when copying is complete.**
- 6. This camcorder: Stop playback.**







- We recommend powering the camcorder from a household power outlet.
- The quality of the edited tape will be lower than that of the original.
- By default, the on-screen displays will be embedded in the output video signal, but you can select to turn off the screen displays or select the data that will be displayed instead (□ 43).

Transferring Recordings to a Computer

Windows users only:

With the supplied USB cable and the Roxio MyDVD for Canon software you can transfer the movies and still images you recorded, from the disc to a computer and easily edit them. For further details about using Roxio MyDVD for Canon, refer also to the software's tutorial and help modules.

One-touch Dubbing (Windows XP only)	Insert a blank DVD disc in your computer's DVD drive (with writing capabilities), connect the camcorder and with only pressing the  (print/share) button, create a copy of your DVD you can instantly share ( 105).
Transfer recordings to your computer	You can transfer your recordings even from a disc not yet finalized to edit them on your computer ( 106).
Create a backup disc of your DVD	Transfer your recordings to the computer and even if your computer does not have a DVD drive with writing capabilities, use your camcorder itself to create a copy of your DVD ( 107).

System Requirements

Operating System: Microsoft Windows 2000, Windows ME, Windows XP

Minimum Hardware: Pentium III 1 GHz or higher (1.5 GHz or greater, recommended)
128 MB RAM (256 MB or greater, recommended)
10 GB hard drive space (20 GB or greater, recommended)
Video adapter and display supporting at least 1024 x 768 resolution, 16 bit color

Software Requirements: Microsoft Windows Media Player 9 or later

Internet connection (for user registration).



- You will need an internet connection to register the software when you first install Roxio MyDVD for Canon.
- Check the orientation of the USB cable and make sure you connect it properly.
- Operation may not work correctly depending on the specifications and settings of your computer.

○ **For support concerning Roxio MyDVD for Canon:**

Canon Inc. and the Canon related customer support centers do not provide support concerning the Roxio MyDVD for Canon software. For any questions or technical issues regarding the software, its installation and operation, please contact directly Sonic Solutions customer support representatives or access online the Internet pages listed below.

• North America

Web Based Service: <http://support.roxio.com>

Phone assistance: 866-279-7694 (toll free) or 905-482-5555 (Canada only)

9:00 A.M. to 6:00 P.M., U.S Pacific Time - excluding Weekend and Holidays

• Europe

Web Based Service:

Germany

<http://www.roxio.com/en/support/de/emc/index.jhtml>

France

<http://www.roxio.com/en/support/fr/emc/index.jhtml>

U.K

<http://www.roxio.com/en/support/uk/>

Phone assistance: Germany 0190-735096; France 0892-460909; U.K 0906-7320288

1:00 P.M. to 10:00 P.M., GMT - excluding Weekend and Holidays

• China/Taiwan

Web Based Service:

<http://www.sonic taiwan.com/support/techsupport.aspx>

sonicsupport@gil.com.tw

Phone assistance: 02-2658-8765 (Taiwan)

Installing the Software

Start your computer and insert the Roxio MyDVD for Canon software CD-ROM to your computer's CD or DVD drive. Continue the installation process following the indications on the screen.

If the installation program does not run automatically, open Windows "My Computer".

Double-click on the icon of the CD-ROM or DVD drive where you inserted the disc and double-click on the "SETUP.EXE" file to run it. Note that on some computers, the ".EXE" suffix may not be displayed.



- Once the installation of Roxio MyDVD for Canon finishes, make sure to connect to the Internet to complete the user registration online. Without completing the online user registration, you will not be able to use any of the software's functions.
- Depending on the speed of your Internet connection, the registration process may take some time.

Connecting the Camcorder and Running the Software

1. Power the camcorder from a household power outlet.
2. Start the computer and turn on the camcorder and set it to play movies ().
3. Connect the camcorder to the computer using the USB cable.
4. Run the program from the desktop shortcut or from Windows Start menu.



- Check the orientation of the USB cable and make sure you connect it properly.
- Operation may not work correctly depending on the specifications and settings of your computer.
- Recordings made in LP mode in Widescreen (16:9 aspect ratio) on a DVD-RW that was initialized in VR mode cannot be transferred to the computer.
- DVD copies and DVD backup discs created with MyDVD for Canon cannot be unfinalized using the camcorder.
- Do not connect the camcorder to a computer with the USB cable during the following operations:
 - Deleting all scenes
 - Protecting the disc
 - Setting the disc title
 - Initializing the disc
 - Finalizing or Unfinalizing the disc
 - Erasing all still images from the disc or card
 - Copying still images between the disc and card
 - Erasing all transfer orders
 - Erasing all print orders





One-Touch Dubbing (Windows XP only)



If your computer is equipped with a DVD drive with writing capabilities, with the touch of one button you can make a copy of your DVD and burn it to an empty media in your computer's drive without the need to run the program.

1. Connect the camcorder to the computer but do not run MyDVD for Canon.

Steps 1 through 3 above.

2. Insert a finalized disc in the camcorder and load a brand new media in your computer's DVD drive.

- To make a copy of a DVD-RW recorded in VR mode, load a blank DVD-RW in your computer's DVD drive. To make a copy of a DVD-R or DVD-RW recorded in VIDEO mode, you can load a blank DVD-R or DVD-RW.
- You can also use a fully erased DVD-RW disc instead of a brand new media. However, depending on the condition of the disc, the operation will take longer. To fully erase a DVD-RW disc you will need DVD authoring/mastering software (for example Roxio Record Now!) installed in your computer.
- When all the connections are completed and the software recognizes a blank media ready in the DVD drive, the  (print/share) button will light on and the message "PRESS  TO COPY" will appear on the camcorder's display.
- If you did not complete the online user registration after installing the software ( 104), the  (print/share) button will not light up even though all the preparations are completed correctly.

- If the  (print/share) button does not light up even if you completed the user registration, verify that the  icon appears on your computer's desktop toolbar. If it does not, disconnect the USB cable, restart the computer and connect the camcorder to the computer again.

3. Once the button's blue light is on, press the (print/share) button.

- The  button will flash while the copying is in progress, and will go off once the copy is completed.
- The copied disc will automatically be finalized and ejected from the drive.



Operation may not work properly if you connect more than one DC20/DC10 camcorder to the computer at the same time.



- If the operation is interrupted:
 - "OPERATION CANCELED" will be displayed on the camcorder's screen.
 - To restart the operation you will need to insert a new blank disc in your computer's DVD drive and restore the connections.
 - The operation will be canceled if you eject the disc from the camcorder, open the disc tray of your computer's DVD drive, disconnect the USB cable or run the Roxio MyDVD for Canon software.
- We recommend powering the camcorder from a household power outlet while it is connected to the computer.
- The time required to complete the one-touch dubbing will vary depending on the scene recording conditions and the amount of free space remaining on the source disc.
- You need to have DVD playback software installed in your computer in order to play the disc.
- Finalized DVD discs created with MyDVD for Canon cannot be unfinalized using the camcorder.
- For further details about restrictions when using MyDVD for Canon, refer also to the "README" section in the software's help modules.
- Refer also to the computer's instruction manual.

Transferring Recordings to the Computer

You can transfer the movies and still images recorded on a disc, even one not yet finalized, to your computer for further editing.

- 1. Connect the camcorder to the computer and run MyDVD for Canon as previously described ( 105).**
- 2. Click on the "DVD-Video" option in the New Project tab.**
- 3. Click on the "Open Disc" icon.**
- 4. Click on the "Import" button.**
 Thumbnails of the imported scenes and still images will be displayed in the video project screen.
- 5. To save the project, click on "Save Project" from the Project Tasks palette.**

The scenes and still images displayed in the main screen will be saved.



Recordings made in LP mode in Widescreen (16:9 aspect ratio) on a DVD-RW that was initialized in VR mode cannot be transferred to the computer.

Creating Backup Copies of your DVD

You can create a backup copy of your finalized disc on a common (12 cm) DVD disc. Even if your computer does not have a DVD drive with writing capabilities, you can use the camcorder itself to create a backup disc on an 8 cm Mini DVD disc.

1. **Connect the camcorder to the computer and run MyDVD for Canon as previously described (105).**
2. **Insert a finalized disc in the camcorder and load a brand new media in your computer's DVD drive.**
 - To make a copy of a DVD-RW recorded in VR mode, load a blank DVD-RW in your computer's DVD drive. To make a copy of a DVD-R or DVD-RW recorded in VIDEO mode, you can load a blank DVD-R or DVD-RW.
 - You can also use a fully erased DVD-RW disc instead of a brand new media. However, depending on the condition of the disc, the operation will take longer. To fully erase a DVD-RW disc you will need DVD authoring/mastering software (for example Roxio Record Now!) installed in your computer.
3. **Click on the "Make a Backup DVD" option in the New Project tab.**
4. **Select the camcorder as the "Device to read from".**
5. **Select the computer's DVD drive (with writing capabilities) as the "Device to write to".**

If your computer is not equipped with a DVD drive with writing capabilities, select the camcorder also as the "Device to write to".

6. **Click on the "Copy" button and follow the indications on the screen.**
 - When the "Your disc was created successfully" screen appears, click on "OK" to finish the task and eject the backup disc.
 - When the "Please insert a blank or rewritable DVD into the DVD drive" dialog box appears, if the tray of a DVD drive other than the one selected in step 5 is ejected, click on "Cancel" and start again from step 4. When this problem occurs, if the source disc is a DVD-RW disc, some recordings on the source disc might be lost.



- If you create a backup copy of a disc containing only still images, the backup copy cannot be read with the camcorder.
- Recordings made in LP mode in Widescreen (16:9 aspect ratio) on a DVD-RW that was initialized in VR mode cannot be transferred to the computer.



- We recommend powering the camcorder from a household power outlet while it is connected to the computer.
- The time required to complete the backup copy will vary depending on the scene recording conditions and the amount of free space remaining on the source disc.
- Finalized DVD discs created with MyDVD for Canon cannot be unfinalized using the camcorder.
- For further details about restrictions when using MyDVD for Canon, refer also to the "README" section in the software's help modules.

Transferring Still Images to a Computer (Direct Transfer)

With the supplied USB cable and Digital Video Software, you can transfer still images to a computer by simply pressing the  (print/share) button.

Preparations

The first time you connect the camcorder to the computer, you need to install the software and set the auto-launch setting. From the second time on, you will only need to connect the camcorder to the computer to transfer images.

1. Install the supplied Digital Video Software.

See *Installing the Software* in the *Digital Video Software* instruction manual.

2. Set the camcorder to view still images ().

3. Connect the camcorder to the computer using the USB cable.

See *Connecting the Camcorder to a Computer* in the *Digital Video Software* instruction manual.

4. Set the auto-launch setting.

- See *Starting CameraWindow* in the *Digital Video Software* instruction manual.
- The direct transfer menu appears on the camcorder screen and the  button lights up.







- Correct performance cannot be guaranteed for discs recorded on another digital device and inserted in this camcorder.
- Do not disconnect the USB cable, remove the disc or memory card, change the position of the  switch or turn off the camcorder or the computer while data is being transferred to the computer (while the camcorder's card or disc access indicator is flashing). Doing so may result in data loss.
- Do not connect the camcorder to a computer with the USB cable during the following operations:
 - Deleting all scenes
 - Protecting the disc
 - Setting the disc title
 - Initializing the disc
 - Finalizing or Unfinalizing the disc
 - Erasing all still images from the disc or card
 - Copying still images between the disc and card
 - Erasing all transfer orders
 - Erasing all print orders
- Operation may not work correctly depending on the software and the specifications/settings of your computer.
- The image files on your disc or memory card and the image files saved on the hard disc drive of your computer are valuable, original data files. If you wish to use image files on your computer, make copies of them first, and use the copied file, retaining the original.



- We recommend powering the camcorder from a household power outlet while it is connected to the computer.
- Refer also to the computer's instruction manual.

○ Users of Windows XP and Mac OS X:

Your camcorder is equipped with the standard Picture Transfer Protocol (PTP) allowing you to download still images (JPEG only) by simply connecting the camcorder to a computer via USB cable without installing the software from the DIGITAL VIDEO SOLUTION DISK.

 ALL IMAGES...	Transfers all images to the computer.
 NEW IMAGES...	Transfers only those images that have not yet been transferred to the computer.
 TRANSFER ORDERS...	Transfers images with transfer orders to the computer. Transfer orders (📄 111) are only available for images recorded on the memory card.
 SELECT & TRANSFER...	Allows you to select an image and transfers the selected image to the computer.
 WALLPAPER...	Allows you to select a still image and transfers the selected image to the computer as wallpaper.

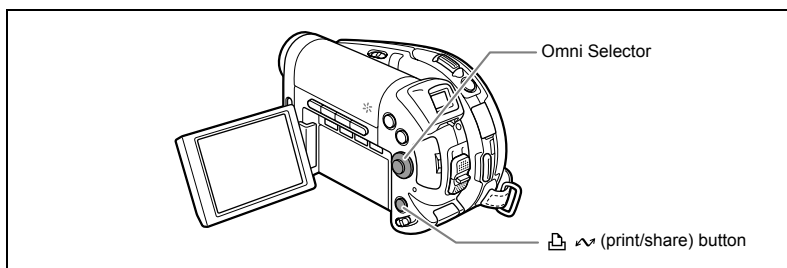



Transferring Images

To transfer images with transfer orders, you need to set the transfer orders beforehand (📄 111).

1. Select (▲▼) a transfer option.

2. Press the  button.

[ ALL IMAGES] [ NEW IMAGES] [ TRANSFER ORDERS]:

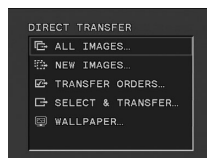

- The images are transferred and displayed on the computer.
- The camcorder returns to the transfer menu once the transfer is complete.
- To cancel the transfer, select [CANCEL] and press (SET) or press the MENU button.



If you select [ SELECT & TRANSFER] or [ WALLPAPER]:

3. Select (▲▼) the image you wish to transfer.

4. Press the  button.

- [ SELECT & TRANSFER]: The selected image is transferred and displayed on the computer. To continue transferring, select another image.
- [ WALLPAPER]: The selected image is transferred to the computer and displayed on the desktop.
- Press the MENU button to return to the transfer menu.



- You can press (SET) to transfer the images, instead of the  button. With [ALL IMAGES], [NEW IMAGES] or [TRANSFER ORDERS], a confirmation message appears. Select [OK] and press (SET).
- When the camcorder is connected to the computer and the image selection screen is displayed, press the MENU button to return to the transfer menu.
- Even when still images recorded on the disc are correctly transferred to the computer, they will still be marked as images not yet transferred ("NEW IMAGES").

Transferring Images with Transfer Order Settings

You can select still images recorded on the memory card to transfer to the computer. These transfer settings are compatible with the Digital Print Order Format (DPOF) standards. Up to 998 images can be selected.

Selecting Still Images to Transfer (Transfer Order)

Do not connect the USB cable to the camcorder while setting the transfer orders.



1. Set the camcorder to view still images recorded on the memory card (**PLAY** / **1**).
2. Press the **FUNC.** button.
3. First, select (**▲▼**) the [**TRANSFER ORDER**] symbol and press (**SET**). Set it (**◀▶**) to [**ON**] and press (**SET**).
4. Press the **FUNC.** button to close the menu.
To cancel the transfer order, select [**OFF**] in step 3.

Setting Transfer Orders from the Index Screen

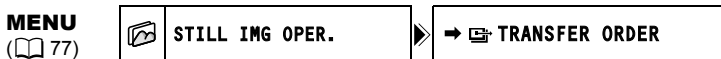







1. Set the camcorder to view still images recorded on the memory card (**PLAY** / **1**).
2. Move the zoom lever toward **W**.
The stills index screen appears with up to six still images.
3. Press the **MENU** button and use the omni selector (**▲▼** , **SET**) to select the [**STILL IMG OPER.**] menu and then select the [**TRANSFER ORDER**] option.
4. Bring (**▲▼** , **◀▶**) the cursor **☞** to the image you want to transfer and press (**SET**).
 - " **☞** " appears on the image.
 - To cancel the transfer order, press (**SET**) again.
5. Press the **MENU** button to close the menu.

Erasing All Transfer Orders

MENU

( 77)



1. Set the camcorder to view still images recorded on the memory card ( / ).
2. Press the MENU button and use the omni selector (, ) to select the [STILL IMG OPER.] menu and then select the [ ORD. ALL ERASE] option.
3. Select [YES] and press ().
All "" disappear.
4. Press the MENU button to close the menu.

Printing Still Images



The camcorder can be connected to any PictBridge compatible printer. You can use the print order settings for direct printing of still images recorded on the memory card (□ 120).
Canon printers: SELPHY CP, SELPHY DS and PIXMA printers

E

Connecting the Camcorder to the Printer

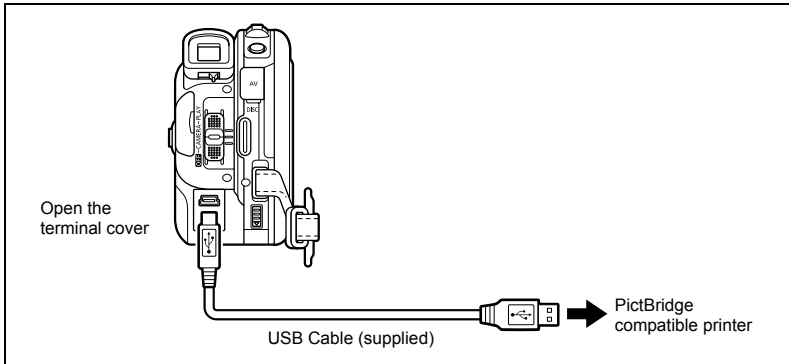

1. Make sure that the memory card or disc containing the still images you want to print is loaded in the camcorder.
2. Turn on the printer.
3. Set the camcorder to view still images (**PLAY** ·).
4. Select as the media for the still images, the media from where you want to print the images.
5. Connect the camcorder to the printer using the supplied USB cable.
 - appears and changes to . The symbol will not appear if the memory card or disc contains still images that cannot be viewed with this camcorder.
 - The (print/share) button lights up and the current print setting will be displayed for approx. 6 seconds.



If continues to flash (for more than 1 minute) or if does not appear, the camcorder is not correctly connected to the printer. In such case, disconnect the cable from the camcorder and the printer. Turn them both off and then on again and reconnect the camcorder to the printer.





- A “” will appear for images that cannot be printed.
- We recommend powering the camcorder from a household power outlet.
- Refer also to the printer's instruction manual.
- The print setting menu may differ slightly depending on the connected printer.

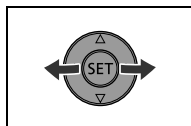

Printing with the (Print/Share) Button

You can print a still image without changing the settings by simply pressing the  (print/share) button.

1. Select () the still image you wish to print.



2. Press the  (print/share) button.

- Printing starts. The  button flashes and stays on when printing is complete.
- To continue printing, select () another still image.

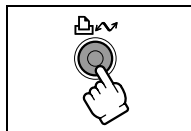

Printing after Selecting the Print Settings

You can select the number of copies and other settings for printing. The setting options vary depending on your printer model.

1. Press ().

- The print setting menu appears.
- Depending on the printer, the message "BUSY." may appear before the camcorder displays the print setting menu.

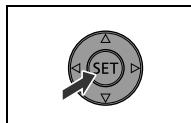

2. Select the print settings ( 116).

3. Select () the [PRINT] option and press ().



- Printing starts. The print setting menu disappears when printing is complete.
- To continue printing, select () another still image.



- Images not recorded with this camcorder, uploaded from a computer, edited on a computer and images whose file names have been changed may not be printed correctly.
- Observe the following precautions during printing:
 - Do not turn off the camcorder or the printer.
 - Do not change the position of the  switch.
 - Do not disconnect the USB cable.
 - Do not remove the disc or memory card.
- If the message "BUSY" does not disappear, disconnect the USB cable from both the camcorder and the printer and then reconnect them again.





○ **Cancel Printing**

Press () during printing. A confirmation dialog appears. Select [OK] and press (). With Canon's PictBridge compatible printers, the printing will stop immediately (even if not completed) and the paper will be fed through.

○ **Printing Errors**

If an error occurs during the printing process, an error message appears ( 129).

- Canon's PictBridge compatible printers: Resolve the error. When printing does not resume automatically, select [CONTINUE] and press (). If [CONTINUE] cannot be selected, select [STOP], press () and retry printing. Refer also to the printer manual for details.
- If the error still persists and printing does not restart, disconnect the USB cable and turn the camcorder off. Turn it on again to view still images () and reconnect the cable.

○ **When you have finished printing:**

1. Disconnect the cable from the camcorder and printer.
2. Turn off the camcorder.

Selecting Print Settings

The procedure for selecting the number of copies is common to all printers. Other print setting procedures vary depending on your printer model.

Selecting the Number of Copies

A maximum of 99 copies can be selected for each still image.

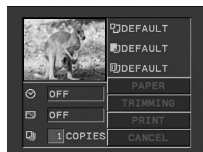

1. In the print setting menu, select (▲▼, ◀▶)  (COPIES) and press (SET).

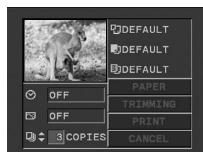

2. Select (▲▼) the number of copies and press (SET).



Setting the Print Style

PAPER	PAPER SIZE	Available paper sizes vary depending on the printer model.
	PAPER TYPE	PHOTO, FAST PHOTO, DEFAULT
	PAGE LAYOUT	BORDERLESS, BORDERED, 2-UP, 4-UP, 8-UP, 9-UP, 16-UP, DEFAULT
 (date print)		ON, OFF, DEFAULT
 (print effect)		ON, OFF, VIVID, NR, VIVID+NR, DEFAULT



- Print setting options and [DEFAULT] settings vary depending on the printer model. For details, refer to the printer's instruction manual.
- [BORDERED]: The image area remains relatively unchanged from the recorded image when it is printed. [BORDERLESS]: The center portion of the recorded image is printed at an enlarged size. The top, bottom and sides of the still image may be slightly trimmed out.
- [VIVID], [VIVID+NR] and [NR] can be selected with Canon PIXMA/SELPHY DS printers.
- **Canon printers:**
When selecting [2-UP], [4-UP], [9-UP] or [16-UP] for [PAGE LAYOUT], set the [PAPER SIZE] to [10 x 14.8 cm] or [9 x 13 cm]. Canon PIXMA/SELPHY DS printers: you can also print on the specially designed Photo Stickers sheets. When selecting [8-UP], set the [PAPER SIZE] to [CREDITCARD]. Canon PIXMA/SELPHY DS printers: you can also print on the specially designed Photo Stickers sheets.

Paper Settings

1. In the print setting menu, select (▲▼, ◀▶) [PAPER] and press (SET).

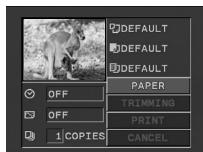

2. Select (▲▼) the paper size and press (SET).
Select the paper size of the paper set in your printer.



3. Select (▲▼) the paper type and press (SET).
Select the paper type of the paper set in your printer.



4. Select (▲▼) a layout option and press (SET).

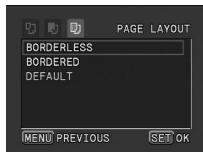

Including the Date in the Print

1. In the print setting menu, select (▲▼, ◀▶) ☺ (date) and press (SET).

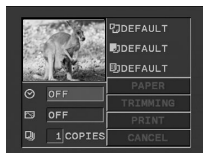

2. Select (▲▼) a date print option and press (SET).

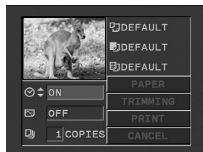

Setting the Print Effect (Image Optimize)

This function uses the camcorder's recording information to optimize the image data, yielding high quality prints.

1. In the print setting menu, select (▲▼, ◀▶)

☑ (print effect) and press (SET).

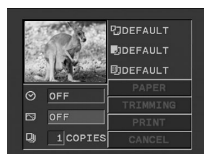

2. Select (▲▼) a setting and press (SET).

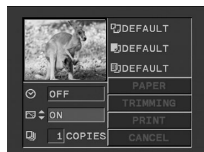

Selecting Trimming Settings

Set the print style before changing the trimming settings.

1. In the print setting menu, select (▲▼, ◀▶) [TRIMMING] and press (SET).

The trimming frame appears.

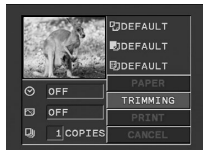

2. Change the size of the trimming frame.

- Move the zoom lever toward **T** to shrink the frame, and toward **W** to enlarge it.
- To cancel the trimming settings, move the zoom lever toward **W** until the trimming frame disappears.



3. Move (▲▼, ◀▶) the trimming frame.

Pressing the MENU button brings you back to the print settings menu.



- About the color of the trimming frame (Canon CP printers only):
 - White: No trimming settings.
 - Green: Recommended trimming size. (The trimming frame may not appear in green depending on the image size, paper size or borders settings.)
 - Red: The image is magnified beyond the recommended size. The print quality will probably be disappointing.
- The trimming setting applies only to one image.
- The trimming setting is canceled with the following operations:
 - When you turn off the camcorder.
 - When you disconnect the USB cable.
 - When you expand the trimming frame beyond its maximum size.

Printing with Print Order Settings

You can select still images for printing and set the number of copies desired. These print order settings are compatible with the Digital Print Order Format (DPOF) standards and can be used for printing on DPOF compatible printers (□ 113). Up to 998 still images can be selected.

Selecting Still Images for Printing (Print Order)

Do not connect the USB cable to the camcorder while setting the print orders.



1. Set the camcorder to view still images recorded on the memory card (/).
2. Press the FUNC. button.
3. First, select () the [PRINT ORDER] symbol and press ().
4. Select () the number of copies and press ().
5. Press the FUNC. button to save the setting and close the menu.

To cancel the print order, set the number of copies to 0 in step 4.

Setting Print Orders from the Index Screen

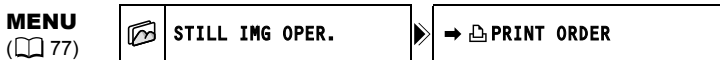

1. Set the camcorder to view still images recorded on the memory card (/).
2. Move the zoom lever toward **W**.
The stills index screen appears with up to six still images.
3. Press the MENU button and use the omni selector (,) to select the [STILL IMG OPER.] menu and then select the [PRINT ORDER] option.
4. Bring (,) the cursor to the image you want to print and press ().
5. Set () the desired number of copies and press ().
“ ” and the selected number of copies appear on the image.
6. Press the MENU button to close the menu.

To cancel the print order, set the number of copies to 0 in step 5.

Erasing All Print Orders

MENU

(77)



1. Set the camcorder to view still images recorded on the memory card (/).
2. Press the MENU button and use the omni selector (,) to select the [STILL IMG OPER.] menu and then select the [ORD. ALL ERASE] option.
3. Select [YES] and press ().
All "" disappear.
4. Press the MENU button to close the menu.

Printing

MENU

(77)



1. Set the camcorder to view still images recorded on the memory card (/).
2. Connect the printer to the camcorder (113).
3. Press the MENU button and select [PRINT].
 - The print setting menu appears.
 - The error message "SET PRINT ORDER" appears if you connect a printer with direct print function and select [PRINT] without having set any print orders.
4. Make sure that [PRINT] is selected and press ().
Printing starts. The print setting menu disappears when printing is complete.



- Depending on the connected printer, you can change some print settings before step 3.
- **Cancel Printing/Printing Errors** (115)
- **Restarting Printing**
Press the MENU button and select [PRINT]. Select [RESUME] in the print setting menu and press (). The remaining images will be printed. Printing cannot be restarted in the following cases:
 - When you change the print order settings.
 - When you delete a still image with print order settings.



Troubleshooting



If you have a problem with your camcorder, refer to this checklist. Consult your dealer or a Canon Service Center if the problem persists.

Power Source



Problem	Solution	
Camcorder will not turn on.	Battery pack is exhausted. Replace or charge the battery pack.	19
	Attach the battery pack correctly.	19
The camcorder switches off by itself.	Battery pack is exhausted. Replace or charge the battery pack.	19
	Power save function has been activated. Turn on the camcorder.	82
LCD/viewfinder switches on and off.	Battery pack is exhausted. Replace or charge the battery pack.	19
Battery pack will not charge.	Charge the battery pack in temperatures between 0 °C and 40 °C.	–
	Battery packs become hot with use and may not charge. Wait until the battery pack temperature is below 40 °C and retry charging.	–
	The battery pack is damaged. Use a different battery pack.	–

Recording/Playback

Problem	Solution	
Buttons will not work.	Turn on the camcorder.	–
	Load a disc.	29
Abnormal characters appear on the screen. The camcorder does not operate properly.	This camcorder uses a microcomputer. External noise or static electricity may cause abnormal characters to appear on the screen. In such case, disconnect the power source and reconnect it after a short time. If the problem still persists, disconnect the power source and press the RESET button with a pointed item. Pressing the RESET button resets all settings.	–
"  " flashes on the screen.	Load a disc.	29
"⏻" flashes on the screen.	Battery pack is exhausted. Replace or charge the battery pack.	19
	The wireless controller will not work.	Set [WL.REMOTE] to [ON].
Video noise appears on screen.	The battery of the wireless controller is exhausted. Replace the battery.	23
	Check that you did not lay the camcorder on its side so the omni selector's  button is pressed down. Place the camcorder upright.	–
Video noise appears on the TV screen.	When using the camcorder in a room where a plasma TV is located, keep a distance between the camcorder and the plasma TV.	–
Even without a disc loaded, when closing the disc compartment cover a motor sound can be heard.	When using the camcorder in a room where a TV is located, keep a distance between the compact power adapter and the power or antenna cables of the TV.	–
	The camcorder is checking if a disc is loaded or not. This is not a malfunction.	–



Problem	Solution	
The disc cannot be ejected.	Turn off the camcorder, disconnect the compact power adapter and remove the battery pack. Restore the power supply and try again.	-
	The camcorder has exceeded its operational temperature. Disconnect the compact power adapter and remove the battery pack and let the camcorder cool down before resuming use.	
The camcorder vibrates.	Depending on the condition of the disc, the camcorder might vibrate occasionally. This is not a malfunction.	-
The disc's rotation can be faintly heard.	The disc is activated from time to time. This is not a malfunction.	-
Occasionally the operation sound can be heard.	The disc is activated from time to time. This is not a malfunction.	-
After using the camcorder for a long time the  lights up in red.	This is not a malfunction. Turn the camcorder off and let it cool for a while before resuming operation.	-



Recording/Editing

Problem	Solution	
"⚡" flashes red on the screen.	The camcorder malfunctions. Consult a Canon Service Center.	-
Image will not appear on the screen.	Set the camcorder to  .	31
	Open the lens cover.	
"SET THE TIME ZONE, DATE AND TIME" appears on the screen.	Set the time zone, date and time.	26
	Recharge the built-in lithium battery and set the time zone, date and time.	133
Pressing the start/stop button will not start recording.	Set the camcorder to  .	31
	Load a disc.	29
	The disc is full ("END" flashes on the screen). Delete some recordings (DVD-RW in VR mode) to free some space or replace the disc.	29 85
	Disc is protected. Cancel the disc protection or replace the disc.	88
	The camcorder has exceeded its operational temperature. Disconnect the compact power adapter and remove the battery pack and let the camcorder cool down before resuming use.	-
	Even after stopping recording, the disc access indicator does not go off.	The scene or still image is being recorded on the disc.
The point where the start/stop button was pressed does not match the beginning/end of the recording.	There is a slight interval between pressing the start/stop button and the actual beginning/end of the recording on the disc. This is not a malfunction.	-
The recording suddenly stops shortly after starting recording.	The disc is dirty. Clean the disc with a soft lens-cleaning cloth or replace the disc.	-
	The camcorder has exceeded its operational temperature. Disconnect the compact power adapter and remove the battery pack and let the camcorder cool down before resuming use.	
Camcorder will not focus.	Autofocus does not work on that subject. Focus manually.	50
	Adjust the viewfinder with the dioptic adjustment lever.	22
	Lens is dirty. Clean the lens.	136

Problem	Solution	
Sound is distorted.	When recording near loud sounds (such as fireworks or concerts), sound may become distorted. This is not a malfunction.	–
A vertical light bar appears on the screen.	Bright light in a dark scene may cause a vertical light bar (smear) to appear. This is not a malfunction.	–
Viewfinder picture is blurred.	Adjust the viewfinder with the dioptic adjustment lever.	22
Cannot edit or delete scenes.	Remove the disc protection.	88
	Scenes cannot be deleted in a DVD-R disc or a DVD-RW disc recorded in VIDEO mode.	–
	You cannot edit or delete scenes on a disc that was protected in another digital device.	–
Cannot add scenes to the playlist.	The disc is full ("END" flashes on the screen). Delete some recordings (DVD-RW in VR mode) to free some space.	29 85
Cannot divide the scene.	You cannot edit or delete scenes on a disc that was protected in another digital device.	–
Cannot edit the disc title.	You cannot add a title to a DVD-R disc after it was finalized.	96
	You cannot add recordings or edit the disc title on a DVD-RW disc after it was finalized. Unfinalize the disc first.	99
	You may not be able to edit the title if you entered it with another digital device.	–
	Disc is protected. Cancel the disc protection or replace the disc.	88
Cannot create a Photomovie scene.	There are no still images recorded on the disc.	–
	The disc is full ("END" flashes on the screen). Delete some recordings (DVD-RW in VR mode) to free some space.	29 85

Playback

Problem	Solution	
Pressing the playback button does not start playback.	Set the camcorder to  .	37
	Load a disc.	29
	You may not be able to play with this camcorder discs recorded or edited with other DVD recorders or computer DVD drives.	–
	Verify that the disc is inserted with the label side facing up.	29
During playback there is video noise, the sound is distorted or the disc cannot be read.	The disc is dirty. Clean the disc with a soft lens-cleaning cloth.	132
	You may not be able to play with the camcorder discs recorded or edited with other DVD recorders or computer DVD drives.	–
Image will not appear on the TV screen.	Check the connections and make sure the TV or VCR is set to the correct input signal.	100
There is a brief stop between scenes.	Depending on the DVD player, there might be a very short stop between scenes during playback.	–
Disc is running, but image will not appear on the TV screen.	TV/VIDEO selector on the TV is not set to VIDEO. Set the selector to VIDEO.	100
	You attempted to play back or dub an incompatible disc. Stop playback/dubbing.	–
No sound from the built-in speaker.	Speaker volume is turned off. Adjust the volume from the [SYSTEM SETUP] menu in the  mode.	41



Problem	Solution	
The keys on the wireless controller do not function.	Check that you did not lay the camcorder on its side so the omni selector's  button is pressed down. Place the camcorder upright.	–

Playing Back the Disc in an External DVD Device



External DVD device refers to DVD players, DVD recorders, computer's DVD drives and other digital devices.

Problem	Solution	
The disc cannot be recognized by the device. Or, even though the disc is read, cannot play back the disc or the picture is distorted.	The disc is dirty. Clean the disc with a soft lens-cleaning cloth.	–
	The disc has not been finalized.	96
Cannot edit my recordings or add recordings to the disc with the DVD device.	DVD-RW discs can only be played back in DVD-RW compatible DVD players and computer drives. Refer to the instruction manual of your DVD device.	–
	Discs recorded with this camcorder cannot be edited and additional recordings cannot be added with an external DVD recorder or DVD device.	–
When recording on a DVD disc in the computer an error message appears.	The camcorder has exceeded its operational temperature. Disconnect the compact power adapter and remove the battery and let the camcorder cool down before resuming use.	–

Memory Card Operation

Problem	Solution	
Memory card cannot be inserted.	Memory card was not facing the correct direction. Turn the memory card over and reinsert it.	28
Memory card cannot be recorded.	Insert a memory card.	28
	Memory card is full. Erase still images to free some space or replace the memory card.	92
	Memory card standard not defined. Initialize the memory card.	95
	The folder and file numbers have reached their maximum value. Set [FILE NOS.] to [RESET] and insert a new memory card.	82
Memory card cannot be played back.	Set the camcorder to  .	39
	Insert a memory card.	28
	Make sure the memory card is selected as the media for still images.	34
Image cannot be erased.	Image is protected. Cancel the protection.	94
"  " flashes in red.	Card error occurred. Turn off the camcorder. Remove and reinsert the memory card. Initialize the memory card if flashing persists.	95

Printing

Problem	Solution	
The printer is not operating even though the camcorder and printer are correctly connected.	1. Set the camcorder to  . 2. Disconnect and reconnect the USB cable. 3. Turn off the printer and turn it back on.	–

Condensation

Moving the camcorder rapidly between hot and cold temperatures may cause condensation (water droplets) to form on its internal surfaces. Stop using the camcorder if condensation is detected. Continued use may damage the camcorder.

Condensation may form in the following cases:

When the camcorder is moved from an air-conditioned room to a warm, humid place

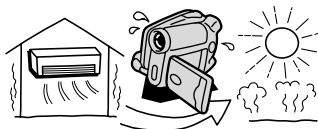

When the camcorder is moved from a cold place to a warm room

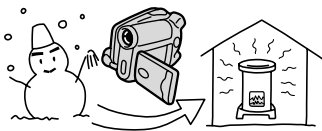

When the camcorder is left in a humid room

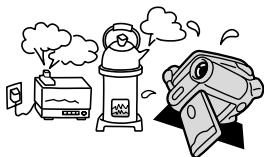

When a cold room is heated rapidly



How to avoid condensation:

- Unload the disc, place the camcorder in an airtight plastic bag and let it adjust to temperature changes slowly before removing it from the bag.

When condensation is detected:

- The camcorder automatically shuts off. If a disc is loaded, remove the disc immediately and leave the disc cover open. Leaving the disc in the camcorder may damage it.
- A disc cannot be loaded when condensation is detected.

Resuming use:

- The precise time required for water droplets to evaporate will vary depending on the location and weather conditions. As a general criterion, wait for 2 hours before resuming use of the camcorder.

List of Messages



Message	Explanation	
SET THE TIME ZONE, DATE AND TIME	You have not set the time zone, date and time. This message appears each time you turn the power on until you set the time zone, date and time.	26
CHANGE THE BATTERY PACK	Battery pack is exhausted. Replace or charge the battery pack.	19
DISC FULL	The disc is full ("END" flashes on the screen). Delete some recordings (DVD-RW in VR mode) to free some space or replace the disc.	29 85
TEMPERATURE TOO HIGH CANNOT RECORD	The camcorder has exceeded its operational temperature. Disconnect the compact power adapter and remove the battery and let the camcorder cool down before resuming use.	-
COPYRIGHT PROTECTED PLAYBACK IS RESTRICTED	You attempted to play back a copyright protected disc.	-
COPYRIGHT PROTECTED DUBBING RESTRICTED	You attempted to dub a copyright protected disc.	-

Disc Related Errors

Message	Explanation	
TEMPERATURE TOO HIGH CANNOT REMOVE DISC	The camcorder has exceeded its operational temperature. Disconnect the compact power adapter and remove the battery and let the camcorder cool down before resuming use.	-
CANNOT RECORD	There is a problem with the disc. Replace the disc.	29
	This message can also appear if condensation has formed. Wait until the camcorder dries completely before resuming use.	126
REACHED THE MAXIMUM NUMBER OF SCENES	The maximum number of scenes has been reached. Delete some recordings (DVD-RW) to free some space or replace the disc.	29 85
CANNOT PLAY DISC	The disc is dirty or you attempted to play back a disc type not supported (not DVD-R/RW).	-
	This message can also appear if condensation has formed. Wait until the camcorder dries completely before resuming use.	126
CANNOT EDIT DISC	There are no scenes to edit or the recording is damaged.	-
	This message can also appear if condensation has formed. Wait until the camcorder dries completely before resuming use.	126
DISC IS FINALIZED CANNOT RECORD	You cannot record additional scenes on a finalized DVD-RW recorded in VIDEO mode. Unfinalize the disc first.	99
UNFINALIZE THE DISC	You cannot record additional scenes or convert still images to a Photomovie scene on a finalized DVD-RW recorded in VIDEO mode. Unfinalize the disc first.	99
DISC IS PROTECTED	The disc is protected. Replace the disc or remove the disc protection.	88
DISC ERROR	Disc could not be read. Try cleaning it or replace the disc.	132
	This message can also appear if the camcorder has exceeded its operational temperature. Disconnect the power adapter and remove the battery and let the camcorder cool down before resuming use.	-
	This message can also appear if condensation has formed. Wait until the camcorder dries completely before resuming use.	126

Message	Explanation	
ACCESS ERROR	There was a disc error when reading the disc or attempting to write onto it. Try cleaning the disc or replace it.	132
	This message can also appear if condensation has formed. Wait until the camcorder dries completely before resuming use.	126
DISC COVER IS OPEN	Verify the disc is correctly inserted and close the disc cover.	29
NO DISC	No disc is loaded. Insert a disc.	29
	You inserted a disc recorded in a different Television System (NTSC).	–
	This message can also appear if condensation has formed. Wait until the camcorder dries completely before resuming use.	126
UNABLE TO RECOVER DATA	Could not recover a corrupted file. Initialize the disc.	89
	This message can also appear if condensation has formed. If you suspect condensation is the reason, do not initialize the disc and wait until the camcorder dries completely before resuming use.	126
UNABLE TO RECOVER DATA INITIALIZE THE DISC	Could not recover a corrupted file. Initialize the disc.	89
	This message can also appear if condensation has formed. If you suspect condensation is the reason, do not initialize the disc and wait until the camcorder dries completely before resuming use.	126
LOADING THE DISC	The disc is being read. Wait before you start recording.	–
OPENING THE DISC COVER	Do not force the disc cover open before it opens automatically. If a disc is already loaded, this may take a moment.	29

Memory Card Related Messages

Message	Explanation	
NO CARD	Memory card not is inserted into the camcorder.	28
NO IMAGES	No images are recorded on the memory card.	–
CARD ERROR	A memory card error occurred. The camcorder cannot record or display the image. The error may be temporary. If the message disappears after 4 seconds and " " flashes red, turn the camcorder off, remove the card and reinsert the card. If " " changes to green, you can continue recording/playback.	–
CARD FULL	Memory card is full. Erase some images to free some space or replace the memory card.	92
NAMING ERROR	The folder and file numbers have reached their maximum value.	–
UNIDENTIFIABLE IMAGE	The image file is corrupted or it was saved using a compression method other than that compatible with this camcorder (JPEG).	–
 TRANSFER ORDER ERROR	You attempted to set more than 998 transfer orders.	111
TOO MANY STILL IMAGES DISCONNECT USB CABLE	Disconnect the USB cable and decrease the number of still images on the memory card or disc to less than 1800. Images cannot be erased from a DVD-R or DVD-RW disc recorded in VIDEO mode. If a dialog appeared on the computer screen, close it. Reconnect the USB cable.	–

Direct Print Related Messages



About Canon PIXMA/SELPHY DS Printers: If the printer's error indicator flashes or an error message appears on the printer's operation panel, refer to the printer's instruction manual.

Message	Explanation
PAPER ERROR	There is a problem with the paper. Wrong paper size is inserted, the ink cannot be used with the selected paper or paper output tray is open.
NO PAPER	Paper is not correctly inserted or there is no paper. If the printer is equipped with a photo paper cassette, specify the paper feed location using the Paper Feed switch.
PAPER JAM	The paper jammed during printing. Select [STOP] to cancel printing. After removing the paper, set some paper again and press the resume button on the printer.
INK ERROR	There is a problem with the ink.
NO INK	The ink cartridge is not inserted or is out of ink.
LOW INK LEVEL	The ink cartridge needs to be replaced soon. Select [CONTINUE] to restart printing.
WASTE TANK FULL	Waste tank is full. Select [CONTINUE] to restart printing. Consult your dealer or a Canon Service Center listed in the Contact List provided with the printer manual to replace the waste tank (waste ink absorber).
FILE ERROR	You attempted to print an image that was recorded with another camcorder, with a different compression, or was edited on a computer.
CANNOT PRINT!	You attempted to print an image that was recorded with another camcorder, with a different compression, or was edited on a computer.
COULD NOT PRINT X IMAGES	You attempted to use the print order settings to print X images that were recorded with another camcorder, with a different compression or were edited on a computer.
SET PRINT ORDER	No still images on the memory card have been marked with a print order.
PRINT ORDER ERROR	You attempted to set more than 998 still images in the print order.
CANNOT TRIM	You attempted to trim an image that was recorded with another camcorder.
READJUST TRIMMING	You changed the print style after you set the trimming settings.
PRINTER ERROR	Cancel printing. Turn off the printer and turn it back on. Check the printer status. If the error still persists, refer to the printer's instruction manual and contact the appropriate customer support center or service center.
PRINT ERROR	Cancel printing, disconnect the USB cable and turn off the printer. After a while, turn the printer back on and reconnect the USB cable. Check the printer status. When you are printing using the button, check the print settings.
HARDWARE ERROR	Cancel printing. Turn off the printer and turn it back on. Check the printer status. If the printer is equipped with a battery, it might be exhausted. In such case, turn off the printer, replace the battery and turn it back on.
COMMUNICATION ERROR	The printer is experiencing a data transfer error. Cancel printing, disconnect the USB cable and turn off the printer. After a while, turn the printer back on and reconnect the USB cable. When you are printing using the button, check the print settings. Or, you attempted to print from a memory card that contains a large number of images. Reduce the number of images.
CHECK PRINT SETTINGS	The print setting cannot be used for printing with the button.
PRINTER IN USE	The printer is in use. Check the printer status.

Message	Explanation
PAPER LEVER ERROR	Paper lever error occurred. Adjust the paper selection lever to the proper position.
PRINTER COVER OPEN	Close the printer cover securely.
NO PRINthead	No print head is installed in the printer or the print head is defective.

Handling Precautions

Camcorder

- Do not carry the camcorder by the LCD panel or the disc cover. Be careful when closing the LCD panel.
- Do not leave the camcorder in places subject to high temperatures (like the inside of a car under direct sunlight), or high humidity.
- Do not use the camcorder near strong electric or magnetic fields such as above TVs, near plasma TVs or mobile phones.
- Do not point the lens or viewfinder at strong light sources. Do not leave the camcorder pointed at a bright subject.
- Do not use the camcorder in dusty or sandy places. Dust or sand getting inside the camcorder may cause damage. Dust and sand can also damage the lens. Make sure to close the lens cover after use.
- The camcorder is not waterproof. Water, mud or salt getting inside the camcorder may cause damage.
- Be careful of heat generated by lighting equipment.
- Do not disassemble the camcorder. If the camcorder does not function properly, consult qualified service personnel.
- Handle the camcorder with care. Do not subject the camcorder to shocks or vibration as this may cause damage.
- Avoid sudden changes in temperature. Moving the camcorder rapidly between hot and cold temperatures may cause condensation to form on its internal surfaces (□ 126).

Battery Pack

DANGER!**Treat the battery pack with care.**

- Keep it away from fire (or it might explode).
 - Do not expose the battery pack to temperature higher than 60 °C. Do not leave it near a heater or inside a car in hot weather.
 - Do not try to disassemble or modify it.
 - Do not drop or knock it.
 - Do not get it wet.
- Charged battery packs continue to discharge naturally. Therefore, charge them on the day of use, or the day before, to ensure a full charge.
 - Attach the terminal cover whenever a battery pack is not in use. Contact with metallic objects may cause a short circuit and damage the battery pack.
 - Dirty terminals may cause a poor contact between the battery pack and the camcorder. Wipe the terminals with a soft cloth.
 - Since storing a charged battery pack for a long time (about 1 year) can shorten its lifecycle or affect performance, we recommend to discharge the battery pack fully and to store it in a dry place at temperatures no higher than 30 °C. If you do not use the battery pack for long periods, charge and discharge it fully at least once a year. If you have more than one battery pack, perform these precautions at the same time for all battery packs.

- Although the battery pack's operating temperature range is from 0 °C to 40 °C, the optimal range is from 10 °C to 30 °C. At cold temperatures, performance will temporarily decline. Warm it in your pocket before use.
- Replace the battery pack if the usable time after full charge diminishes substantially at normal temperatures.

About the battery terminal cover

The battery terminal cover has a []-shaped hole. This is useful when you wish to differentiate between charged and uncharged battery packs. For example, with charged battery packs, attach the terminal cover so that the []-shaped hole shows the white label.

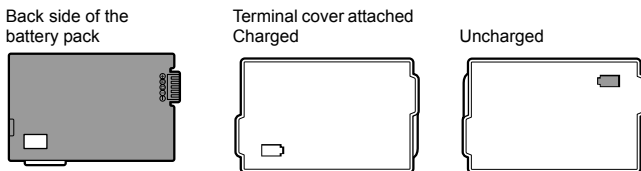

Mini DVD Disc

- Keep the disc clean of dust, dirt or smudges. If it gets dirty use a dry, soft lens-cleaning cloth to remove any fingerprints, dirt buildup or smudges from the disc surface. Clean the disc in a radial motion from its center outwards.
- Never use a chemically treated cloth or flammable solvents such as paint thinner to clean the disc.
- Do not bend, scratch or wet the disc and do not subject it to strong shocks.
- Do not attach labels or stickers on the disc surfaces. The disc may not rotate in a stable manner and this may cause malfunctions.
- Return discs to their case for storage.
- When writing on the label side of the disc, avoid hard tip pens. Use waterproof soft-tipped felt pens instead.
- Moving a disc rapidly between hot and cold temperatures may cause condensation to form on its surfaces. If condensation forms on the disc, put it aside until the water droplets have evaporated completely.
- Never expose the disc to direct sunlight and do not store it in places subject to high temperatures or high humidity.
- Make sure to finalize a DVD-RW disc recorded in VIDEO mode before inserting it in a DVD player, DVD recorder or a computer's DVD drive. Failing to do so can result in the loss of the recorded data.

Memory Card

- We recommend saving backups of memory card images on your computer's hard drive or other external memory device. Image data may be corrupted or lost due to memory card defects or exposure to static electricity. Canon Inc. makes no warranties for corrupted or lost data.
- Do not turn off the camcorder, disconnect the power source or remove the memory card while the card access indicator is flashing.
- Do not use memory cards in places subject to strong magnetic fields.
- Do not leave memory cards in places subject to high humidity and high temperature.
- Do not disassemble memory cards.
- Do not bend, drop, or subject memory cards to shocks and do not expose them to water.
- Moving a memory card rapidly between hot and cold temperatures may cause condensation to form on its external and internal surfaces. If condensation forms on the card, put it aside until the droplets have evaporated completely.
- Do not touch or expose the terminals to dust or dirt.
- Check the direction before inserting the memory card. Forcing a memory card into the slot if it is not correctly oriented may damage the memory card or the camcorder.
- Do not remove the label from the memory card, or affix other labels on the memory card.

Lithium Button Battery

WARNING!

- The battery used in this device may present a fire or chemical burn hazard if mishandled. Do not recharge, disassemble, heat above 100 °C or incinerate the battery.
 - Replace the battery with a CR2025 made by Panasonic, Hitachi Maxell, Sony, Sanyo, or with Duracell2025. Use of other batteries may present a risk of fire or explosion.
 - The used battery should be returned to the supplier for safe disposal.
- Do not pick up the battery using tweezers or other metal tools as this will cause a short circuit.
 - Wipe the battery with a clean dry cloth to ensure proper contact.
 - Keep the battery out of the reach of children. If swallowed, seek medical assistance immediately. The battery case may break and the battery fluids may cause internal damage.
 - Do not disassemble, heat or immerse the battery in water to avoid the risk of explosion.

Built-in Rechargeable Lithium Battery

The camcorder has a built-in rechargeable lithium battery to keep the date/time and other settings. The built-in lithium battery is recharged while you use the camcorder, however, it discharges when the usage time is short, and will become totally discharged if you do not use the camcorder for about 3 months. In such case, recharge the built-in lithium battery: Connect the power adapter to the camcorder and leave it connected for 24 hours with the power switch set to OFF.

Recycling the Built-in Rechargeable Lithium Battery

If you should dispose of your camcorder, first remove the built-in rechargeable lithium battery for recycling according to the recycling system of your country.

The **DC20** camcorder has internal components that can produce high voltage. To reduce the risk of electrical shock, be sure to disconnect all power supply to the camcorder, remove the battery and wait for at least one and a half months before starting the procedure to remove the built-in lithium battery. Be sure to read through the explanation of the whole procedure before starting it.

All the illustrations used below refer to the **DC20**.

1. Remove all the screws shown in the illustrations with a screwdriver.

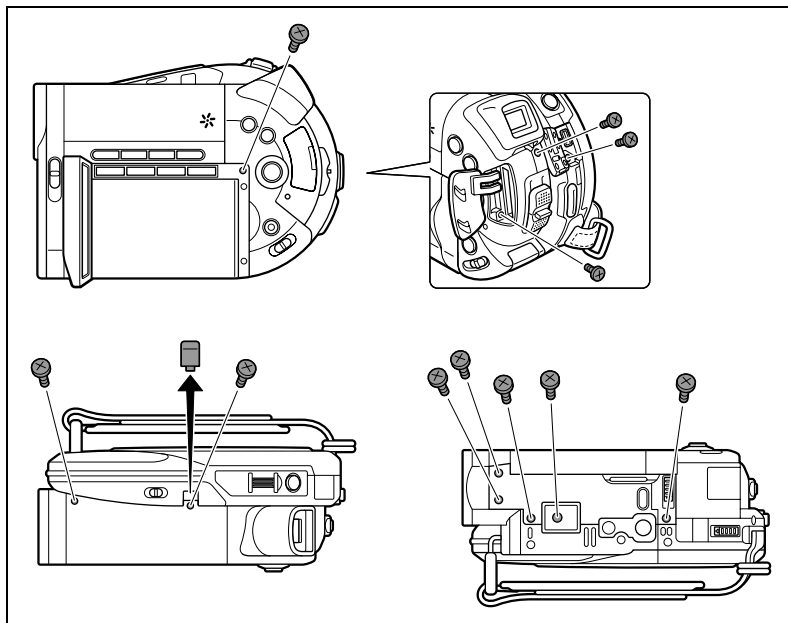

2. Remove the top cover and remove the additional screws under it.

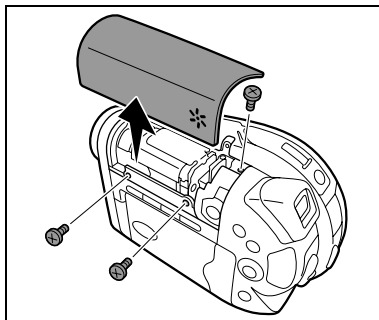

3. Remove the LCD display cover and the back cover.

Detach the cable connectors with a pair of long-nosed pliers or simply cut them with a pair of scissors.

4. Being careful not to touch the part indicated in the illustration remove the additional screws.



DC20 Touching the condenser can present a serious risk of electrical shock.

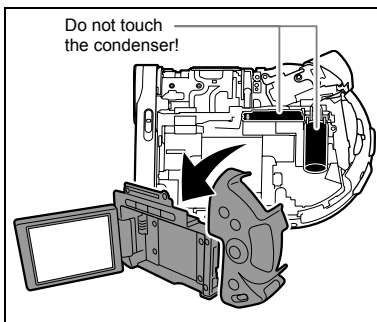

5. Grab the battery firmly with an insulated pair of pliers or a similar tool and twist it repeatedly to detach it from the board. Be careful not to touch the part indicated in the illustration.



DC20 Touching the condenser can present a serious risk of electrical shock.

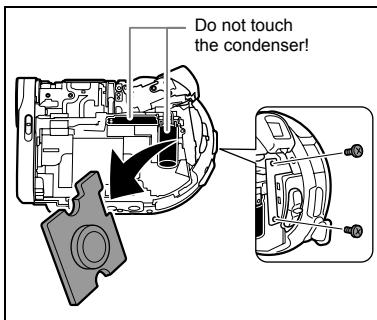

- Do not remove the covers for any other purpose than removing the battery for recycling when disposing the camcorder.
- After removing the battery, keep it out of the reach of children. If swallowed, seek medical assistance immediately. The battery case may break and the battery fluids may cause internal damage.

Maintenance/Others

Storage

- If you do not intend to use the camcorder for a long time, store it in a place free of dust, in low humidity, and at temperatures not higher than 30 °C.
- After storage, check the functions of your camcorder to make sure that the camcorder is still working properly.

Cleaning

Camcorder Body and Lens

- Use a soft, dry cloth to clean the camcorder body. Never use chemically treated cloth or volatile solvents such as paint thinner.
- Use a clean, soft lens-cleaning cloth to gently wipe the lens. Never use tissue paper to clean the lens.

LCD Screen

- Clean the LCD screen using a commercially available lens-cleaning cloth.
- Condensation may form on the surface of the screen when the temperature changes suddenly. Wipe it with a soft dry cloth.

Viewfinder

- Clean the viewfinder screen using a non-aerosol type blower brush or a commercially available lens-cleaning cloth.

Using the Camcorder Abroad

Power Sources

You can use the compact power adapter to operate the camcorder and to charge battery packs in any country with power supply between 100 and 240 V AC, 50/60 Hz. Consult the Canon Service Center for information on plug adapters for overseas use.

Playback on a TV Screen

You can only play back your recordings on TVs compatible with the PAL system. The PAL system is used in the following countries/areas:

Algeria, Australia, Austria, Bangladesh, Belgium, Brunei, China, Denmark, Finland, Germany, Hong Kong Special Administrative Region, Iceland, India, Indonesia, Ireland, Israel, Italy, Jordan, Kenya, Kuwait, Liberia, Malaysia, Malta, Mozambique, the Netherlands, New Zealand, North Korea, Norway, Oman, Pakistan, Portugal, Qatar, Serbia and Montenegro, Sierra Leone, Singapore, South Africa, Spain, Sri Lanka, Swaziland, Sweden, Switzerland, Tanzania, Thailand, Turkey, Uganda, United Arab Emirates, United Kingdom, Yemen, Zambia.

System Diagram (Availability differs from area to area)

E

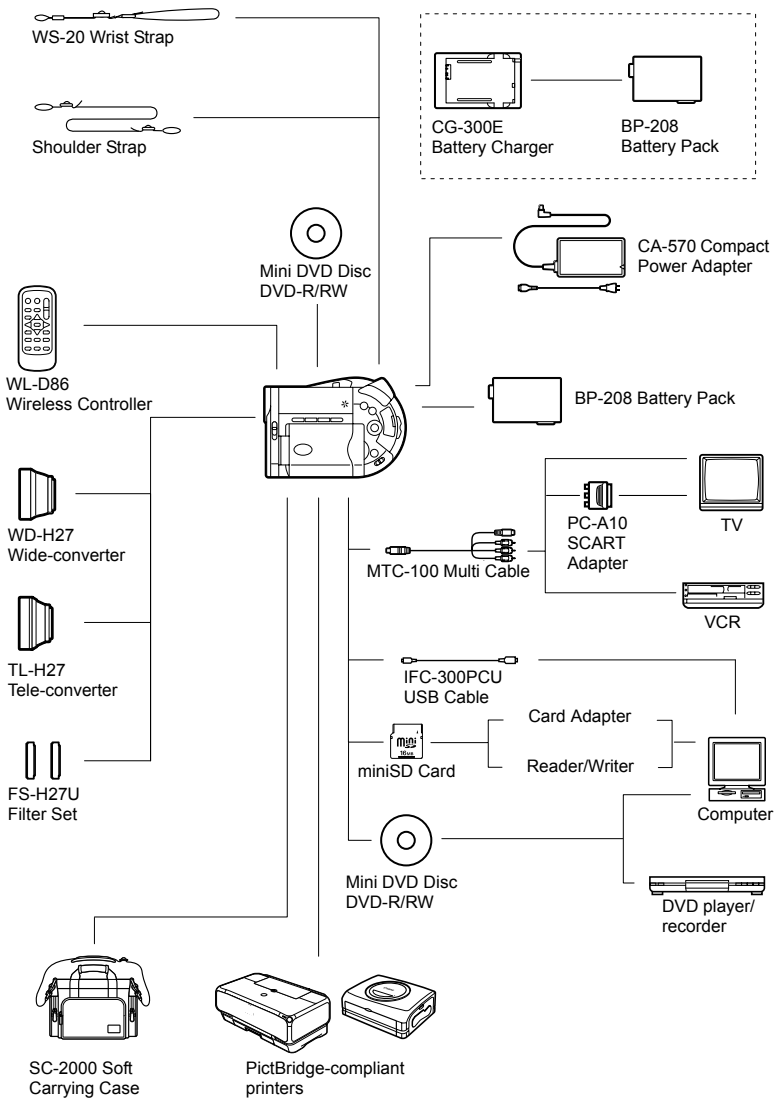

Additional Information

Optional Accessories

Use of genuine Canon accessories is recommended.

This product is designed to achieve excellent performance when used with genuine Canon accessories. Canon shall not be liable for any damage to this product and/or accidents such as fire, etc., caused by the malfunction of non-genuine Canon accessories (e.g., a leakage and/or explosion of a battery pack). Please note that this warranty does not apply to repairs arising out of the malfunction of non-genuine Canon accessories, although you may request such repairs on a chargeable basis.

Battery Packs

When you need extra battery packs, select only the BP-208 battery pack.

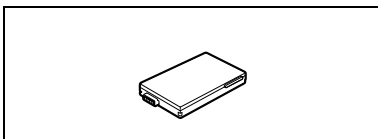

CG-300E Battery Charger

Use the battery charger for charging the battery packs.

Charging Time: 105 min.

Charging time varies according to the charging condition.

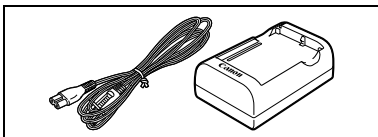

TL-H27 Tele-converter

This Tele-converter lens increases the focal length of the camcorder lens by a factor of 1.7.

- The image stabilizer is not as effective when the Tele-converter is attached.
- The minimum focusing distance with the TL-H27 is 3 m; 3 cm at maximum wide angle.
- When the Tele-converter is attached, a shadow may appear in the picture when you record with flash or assist lamp.

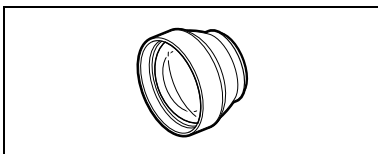

WD-H27 Wide-converter

This lens decreases focal length by a factor of 0.7, giving you a wide perspective for indoor shots or panoramic views.

- When the Wide-converter is attached, a shadow may appear in the picture when you record with flash or assist lamp.

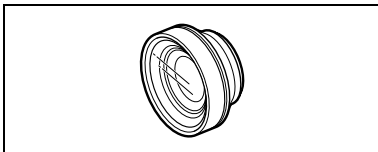

FS-H27U Filter Set

Neutral density and MC protector filters help you to control difficult lighting conditions.

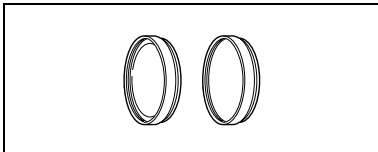

Shoulder Strap

You can attach a shoulder strap for more security and portability. Pass the ends through the strap mount and adjust the length of the strap.

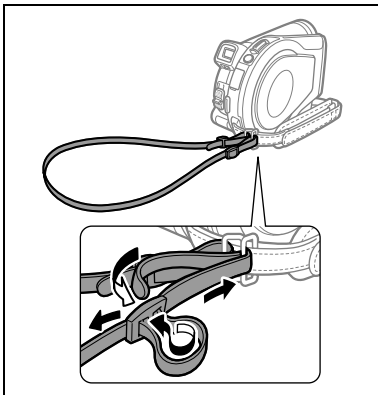

WS-20 Wrist Strap

Use this for extra additional protection for active shooting.

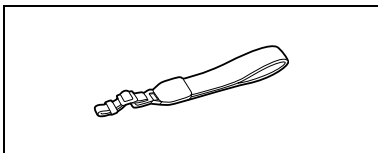

SC-2000 Soft Carrying Case

A handy camcorder bag with padded compartments and plenty of space for accessories.



This mark identifies genuine Canon video accessories. When you use Canon video equipment, we recommend Canon-brand accessories or products bearing the same mark.



Memory Card

Recording media	miniSD Card*
Size of Still Images	1632 x 1224 (DCP20 only), 1280 x 960, 640 x 480 pixels
File Format	Design rule for Camera File system (DCF), Exif 2.2** compliant, DPOF compliant
Image Compression Method	JPEG (compression: Super Fine, Fine, Normal)

* This camcorder has been tested with miniSD cards up to 256 MB. Performance cannot be guaranteed for all miniSD cards.

** This camcorder supports Exif 2.2 (also called "Exif Print"). Exif Print is a standard for enhancing the communication between camcorders and printers. By connecting to an Exif Print-compliant printer, the camcorder's image data at the time of shooting is used and optimized, yielding extremely high quality prints.

Input/Output Terminals

AV Terminal	10-pin multiconnector; Output only Video: 1 Vp-p/75 ohms unbalanced S-Video: Luminance (Y) signal: 1 Vp-p/75 ohms; Chrominance (C) signal: 0.3 Vp-p/75 ohms Audio: -10dBV (47 kohm load)/3 kohm or less
USB Terminal	mini-B

Power/Others

Power supply (rated)	7.4 V DC
Power consumption (SP mode, AF on)	DCP20 5.3 W (viewfinder), 5.4 W (LCD screen in normal brightness) DC10 4.6 W (viewfinder), 4.7 W (LCD screen in normal brightness)
Operating temperature	0 – 40 °C
Dimensions (W x H x D)	48 x 86 x 122 mm excluding protrusions
Weight (camcorder body only)	415 g

CA-570 Compact Power Adapter

Power supply	100 – 240 V AC, 50/60 Hz
Power consumption	17W
Rated output	8.4 V DC, 1.5 A
Operating temperature	0 – 40 °C
Dimensions	52 x 90 x 29 mm
Weight	135 g

BP-208 Battery Pack

Battery type	Rechargeable Lithium Ion Battery
Rated voltage	7.4 V DC
Operating temperature	0 – 40 °C
Battery capacity	850 mAh
Dimensions	39 x 8 x 63 mm
Weight	40 g

Weight and dimensions are approximate. Errors and omissions excepted. Subject to change without notice.

Index

- 16:9 screen ratio 52
- A**
 - Abroad, using the camcorder 136
 - AEB - Exposure bracketing 64
 - AF-assist lamp 55
 - Auto (recording program) 44
 - Auto slow shutter 78
 - Av (recording program) 48
 - AV terminal 100
- B**
 - Battery pack, charging 19
 - Battery pack, remaining charge 17
 - Beach (SCN) 44
 - Beep 81
- C**
 - Card mix 72
 - Condensation 126
 - Connection to a Computer 103
 - Connection to a TV 100
 - Continuous shooting 64
 - Continuous shooting, High-speed 64
 - Copying still images 90
- D**
 - Data code 43
 - Date and time 26
 - Daylight saving time 26
 - Digital effects 68
 - Digital zoom 78
 - Direct printing 113
 - Direct transfer 108
 - Disc title 96
 - Drive mode 64
 - DVD discs 3
 - DVD-R/RW discs 3
- E**
 - Effects 69
 - Erasing still images 92
 - Error messages 127
 - Exposure adjustment 49
 - Exposure bracketing 64
- F**
 - Faders 68
 - File numbers, resetting 82
 - Finalizing the disc 96
 - Fireworks (SCN) 44
 - Flash 54
 - Focus priority 79
 - Focusing frame 33
 - Focusing mode 51
 - FUNC. menu 57
- G**
 - Grip belt 22
- H**
 - High-speed continuous shooting 64
- I**
 - Image enhancing effects 63
 - Image jump 40
 - Image stabilizer 79
 - Index screen, movies 37
 - Index screen, stills 39
 - Initialization, card 95
 - Initialization, disc 89
- L**
 - Language 25
 - LCD backlight 24
 - LCD screen, rotating the 24
 - Lens cover 31, 33
 - Lithium button battery 23, 133
 - LP mode 58
- M**
 - Magnifying a still image 42
 - Maintenance 136
 - Memory card 28
 - MENU 77
 - Metering method 60
 - Mini video light 53
 - miniSD card 28
 - Mode switch 44
 - Movies, playback 37
 - Movies, recording 31
 - Multi-image screen 69

N	
ND filter	138
Night (SCN)	44
O	
Omni selector	9
On-screen displays	43
Original recordings	83
P	
P (recording program)	46
Panoramic images	66
Photomovie scene	87
Playback - Movies	37
Playback - Stills	39
Playlist	83
Portrait (SCN)	44
Power - Battery pack	19
Power - Household power outlet	21
Power save	82
Print order	120
Print/share button	105, 109, 114
Printing	113
Protecting still images	94
Protecting the disc	88
R	
Record review	32
Recording - Movies	31
Recording - Stills	33
Recording data	43
Recording mode	58
Recording programs	44
Recording reminder	17
Recording time display	17
Remote sensor	23
RESET	122
Resetting file numbers	82
Review - Movies	32
Review - Still images	79
Roxio MyDVD for Canon	103
S	
SCART Adapter	101
Scene Editing	83
SCN - Special Scene (recording program)	44
Screen display	16
Screen messages	127
Self-timer	56

Serial number	12
Shoulder strap	139
Shutter speed	47
Slide show	39
Snow (SCN)	44
SP mode	58
Speaker	41
Sports (SCN)	44
Spotlight (SCN)	44
Still image quality	74
Still image size	74
Still images, playback	39
Still images, recording	33
Still images, review	79
Stitch Assist	66
Sunset (SCN)	44
S-video terminal	100

T	
Telephoto	35
Time code display	17
Time zone	26
Transfer order	111
Transferring still images	108
Tripod	36
Troubleshooting	122
Tv (recording program)	47

U	
USB terminal	113

V	
VIDEO mode (disc specification)	3
Viewfinder - Dioptic adjustment	22
Volume	41
VR mode (disc specification)	3

W	
White balance	61
Wide angle	35
Widescreen	52
Wind screen	79
Wireless controller	23

X	
XP mode	58

Z	
Zoom	35



CANON INC.

Canon Europa N.V.

P.O. Box 2262, 1180 EG Amstelveen, the Netherlands

Canon UK Ltd.

CCI Service Centre, Unit 130

Centennial Park, Borehamwood, Hertfordshire, WD6 3SE, England

Telephone 0870-241-2161

Canon Australia Pty. Ltd.

Info-Line: 131383

www.canon.com.au

Canon New Zealand Ltd.

Customer Care: (09) 489 0470

www.canon.co.nz

Canon Singapore Pte. Ltd

1 HarbourFront Avenue, #04-01 Keppel Bay Tower, Singapore 098632

Tel: (65) 6799 8888

Fax: (65) 6799 8882

Canon Hongkong Company Ltd

19/F., The Metropolis Tower, 10 Metropolis Drive, Hungghom, Kowloon, Hong Kong

Canon Latin America, Inc.

Sales & Enquiries: 703 Waterford Way Suite 400 Miami, FL 33126 USA

The information on this manual is verified as of August 1st, 2005.

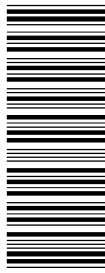

Printed on 100% reused paper.